



Installation and Operation Manual for E4OD and 4R100 Transmissions

US Shift Transmission Control System instruction and operation manual.

www.USshift.com



Baumann Electronic Controls, LLC.

Phone: **(864) 646-8920**

Email: **support@usshift.com**

Address: 158 Hemlock Cove rd, Sunset, SC, 29685

This work and the ideas and processes contained herein are the exclusive property of **Baumann Electronic Controls, LLC** and may not be copied, reproduced, or distributed in any form without the express written consent of **Baumann Electronic Controls, LLC** or Karl Baumann. The technology and processes contained in this product are proprietary and may be used only on a single unit basis or as defined by the written permission of **Baumann Electronic Controls, LLC**.

VF6.3.1 © Copyright 1997 – 2024 by Baumann Electronic Controls, LLC.

All rights reserved.

US Shift Transmission Control System protected by

US Patents #10,100,922 & #10,767,759.

WARRANTY

Baumann Electronic Controls, LLC. is dedicated to producing the highest quality products available in the industry and is committed to customer satisfaction. Because we have no control over the circumstances under which our products are used, we can assume no more responsibility for damages (consequential or otherwise) or defects in materials and workmanship than the original purchase price of our product. Baumann Electronic Controls, LLC. will repair or replace all defective components unconditionally for a period of five years from the date of sale. This warranty does not cover damages due to abuse, improper application, or connection of the device. After the warranty period, Baumann Electronic Controls, LLC. will service this device for a nominal fee.



WARNING: This product can expose you to chemicals, including lead, which are known to the State of California to cause cancer or birth defects or other reproductive harm. For more information, visit www.P65Warnings.ca.gov.

APPLICATION COVERAGE

This system works with all E4OD and 4R100 automatic transmissions. It is recommended that you use the US Shift wiring harness with this system.

CONTENTS

Preparation	Page 4
Connecting the Essentials	Page 5
Setting up the Quick 4	Page 10
Notes on Installation	Page 12
Transmission Diagrams	Page 14
Optional Features	Page 19
Manual Shift Connections	Page 24
Built-In Display / Remote Display	Page 30
Shiftware	Page 38
Important Information	Page 41
Troubleshooting Error Messages	Page 42
Contact	Page 48



IMPORTANT



Before installing the Quick 4 unit, we recommend you read the manual from beginning to end. The information in this manual is very important and, if the unit is improperly installed or if an error message misunderstood, it could result in serious damage to your vehicle and transmission.

Please note that transmission harness modifications are not recommended and any damage caused by improperly shortening a harness will not be covered by our 5-year warranty.

PREPARATION

Pre-1995 Transmissions

The Quick 4 does not support the early ATR (MLPS or Range Sensor) connector used from 1989 to 1994. It was found to not be adequately waterproof. Ford services the old sensor by providing the new one with the updated connector shell and instructions for replacing it. If you don't already have the 1995 and up range sensor, you will need to purchase it. US Shift sells the updated range sensor as well as Ford.

CONNECTING THE ESSENTIALS

Step 1: Ground

Electronic Fuel Injection

Splice the ground wires (Pins 15 & 16 Black) from the Quick 4 into the main ECU (Engine Control Unit) ground wire. Do NOT connect the ground wires to sheet metal or other ground sources. The Quick 4 MUST be connected to the Main ECU ground, as close to the ECU as possible. The reason for this connection method is because the TPS is shared between the two systems and improper grounding will corrupt the TPS signal.

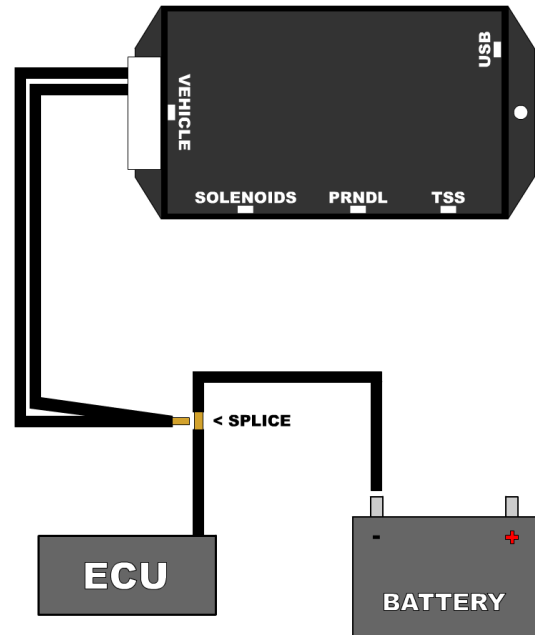

Carbureted / Mechanically-Injected Diesel

Connect the ground wire (Pin 15 Black) from the Quick 4 directly to the battery ground post or negative battery cable. Do NOT connect the ground wire to sheet metal or other ground sources. The Quick 4 MUST be connected directly to the battery ground post or negative battery cable.

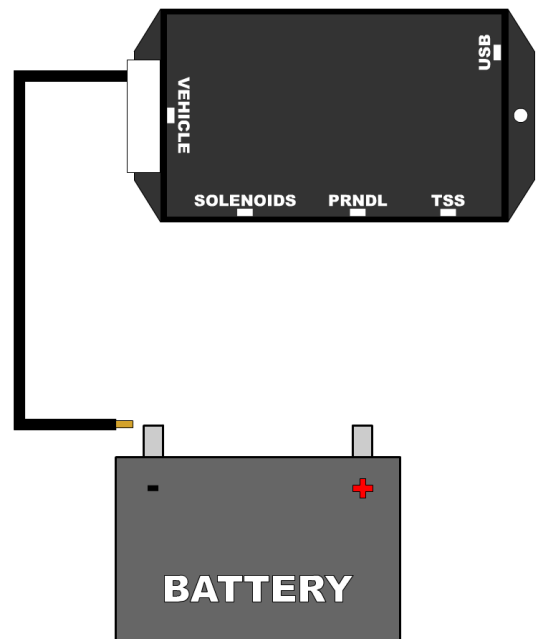

Step 2: Power

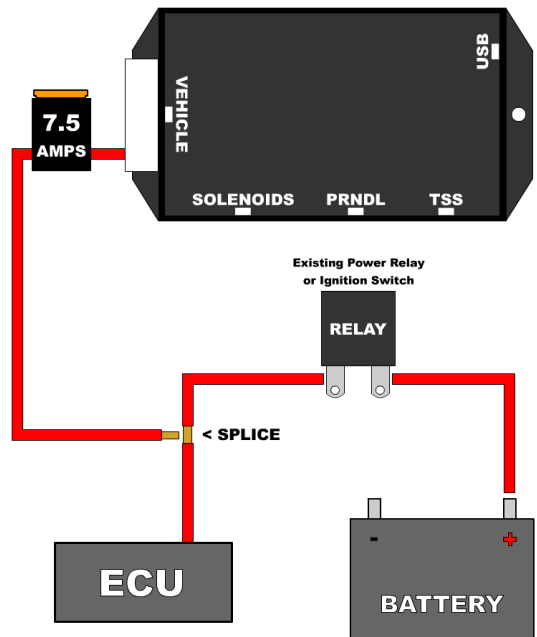

Electronic Fuel Injection

Splice the power wire (Pin 9 Red with 7.5 Amp fuse) from the Quick 4 into the main ECU (Engine Control Unit) ignition-switched power wire. Power should be supplied during cranking as well as while running, which is vital to the Quick 4 operating properly.

Carbureted / Mechanically-Injected Diesel

Connect the power wire (Pin 9 Red with 7.5 Amp fuse) from the Quick 4 to ignition-switched power wire. Do NOT use accessory-switched power. Power should be supplied during cranking as well as while running, which is vital to the Quick 4 operating properly.

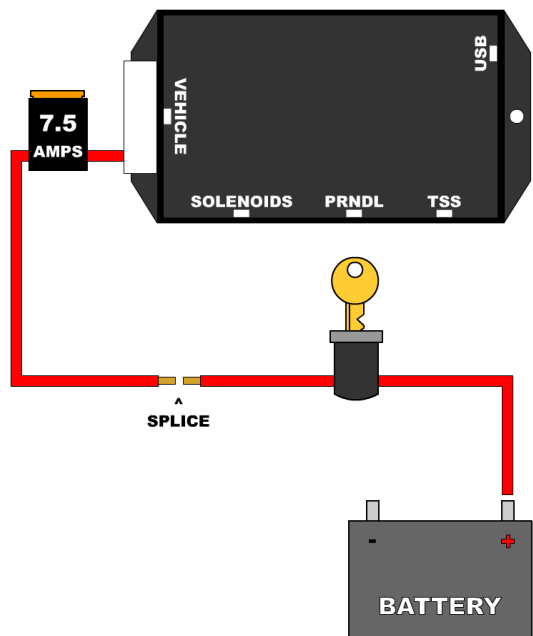

Step 3: Throttle Position Sensor / Accelerator Pedal Position Sensor

Electronic Fuel Injection

Splice the Throttle Position Sensor signal wire (Pin 3 Green) from the Quick 4 into the Throttle Position Sensor (TPS) signal input of the ECU (Engine Control Unit). The orange wire won't be needed. If the vehicle has Electronic Throttle Control, use the Accelerator Pedal Position (APP) Sensor instead of the TPS.

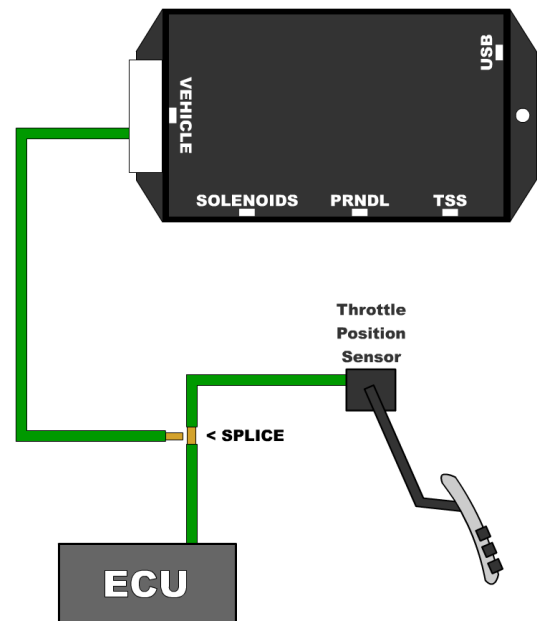

Carbureted / Mechanically-Injected Diesel

Attach the 3 Throttle Position wires from the Quick 4 to the Throttle Position Sensor. Pin 16 Black is dedicated ground. Pin 11 Orange is +5v reference feed. Pin 3 Dark Green is the position sensor signal. See the "Throttle Position Sensor" section for details.

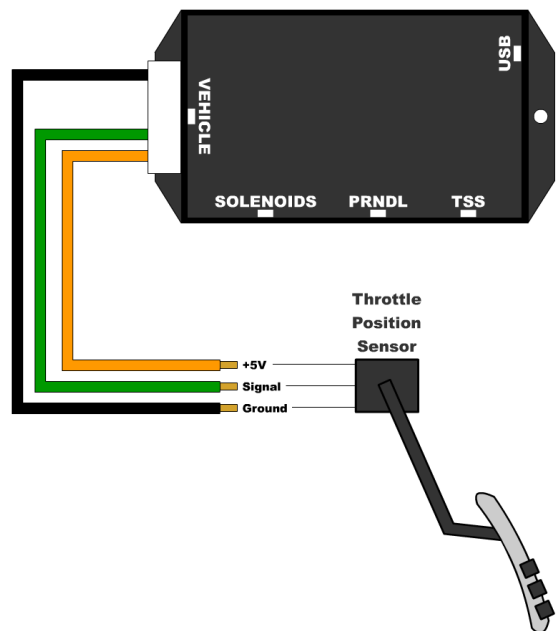

Basic Vehicle Connections EFI Applications

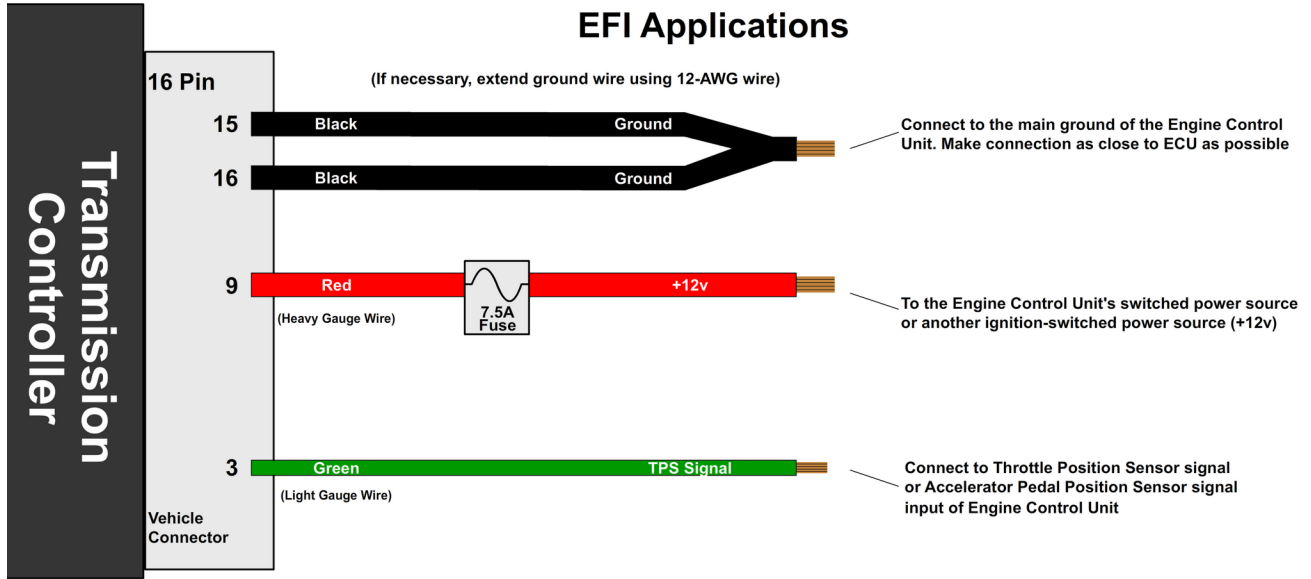

Basic Vehicle Connections Carbureted and Mechanically-Injected Diesel Applications

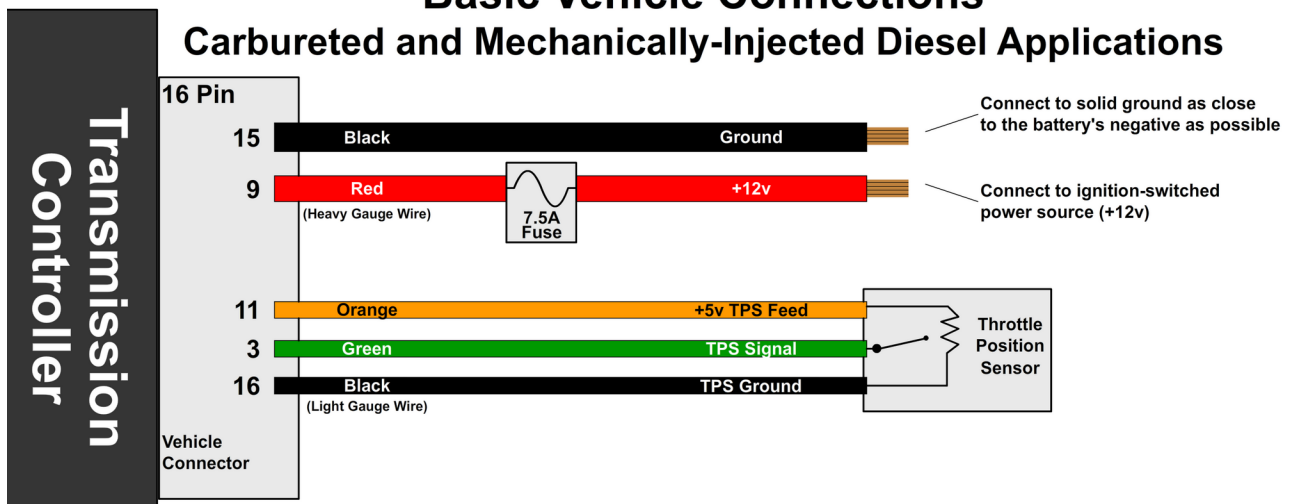

VEHICLE PINOUT

BACK VIEW
(FRONT PLUGS IN, WIRES COME OUT OF THE BACK)

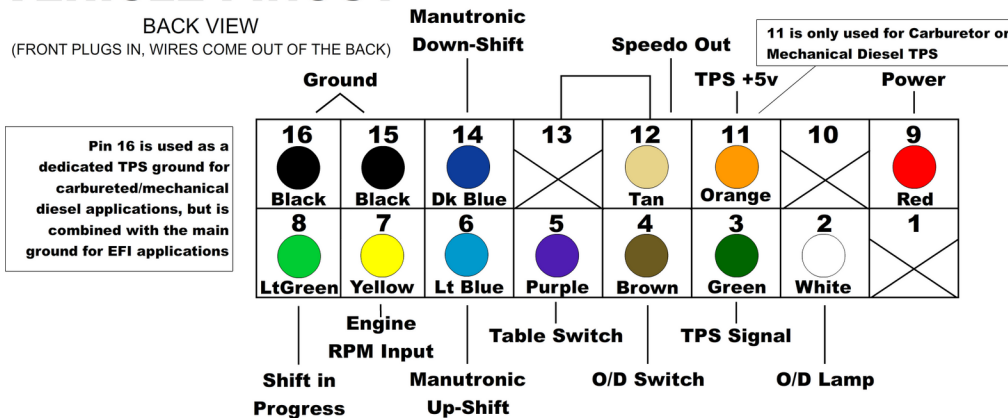

Step 4: Transmission Connectors

Connect the Solenoid, PRNDL, and TSS cables to the transmission. Additionally, connect the Neutral Safety Switch and the Backup Lamp Switch (See page 16). An output shaft speed sensor, a VSS, or an electronic speedo can be used for speed input.

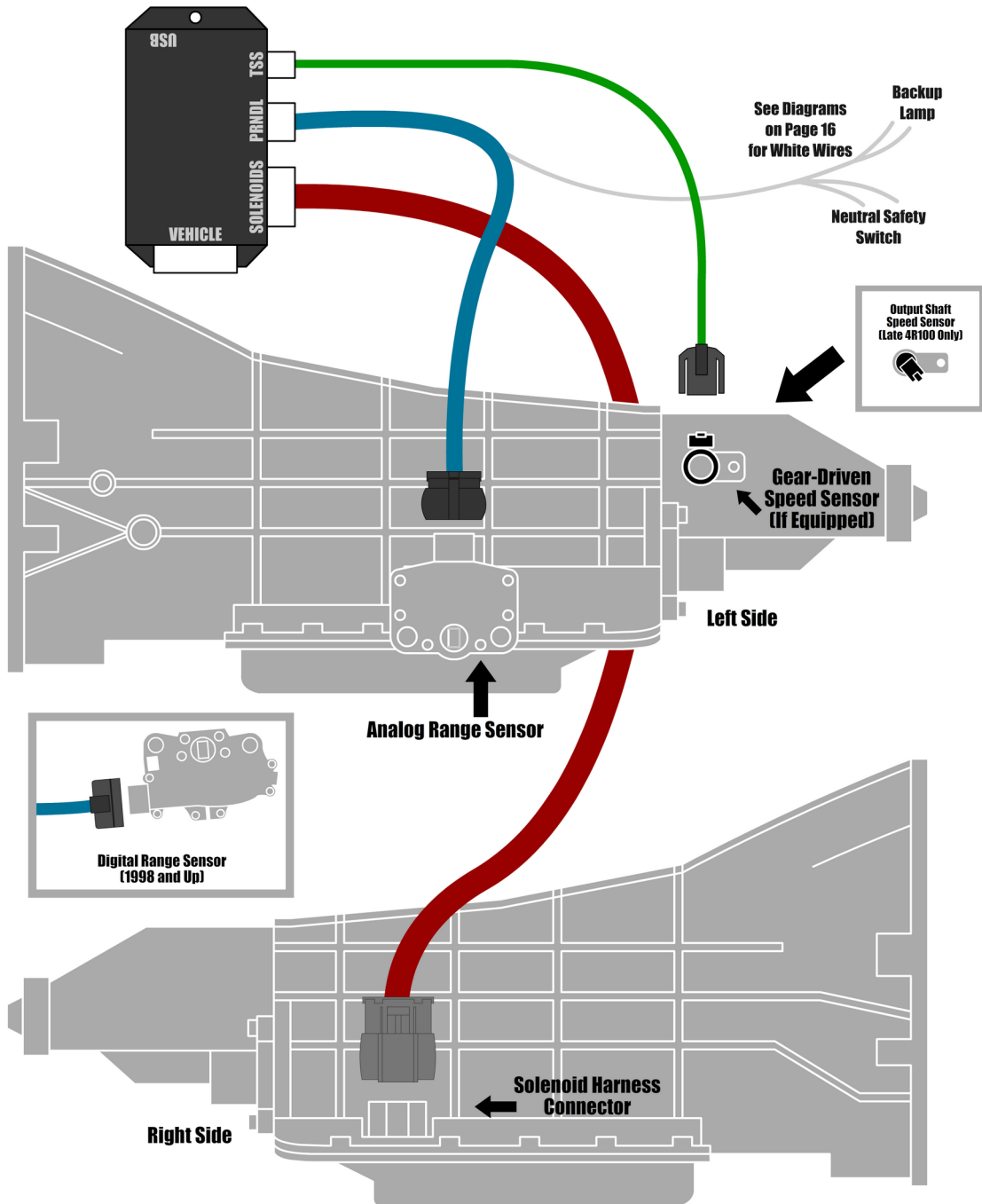

Step 5: Optional Features

Connect any extra features you wish to use. See the "Optional Features" section for details.

SETTING UP THE QUICK 4

Step 6: Connect Remote Display (If Applicable)

If you have a remote display, use the attached cable and insert it into the 3.5mm jack on the right side of the controller, located next to the USB port.

Step 7: Calibration

Verify that the correct calibration is loaded on the Quick 4. A standard calibration specific to your order is loaded before shipment. However, if the transmission configuration has changed since the order was placed, you'll need to connect the Quick 4 to a Windows PC and install the Shiftware Tuning Software, which can be obtained from our website (under Support - Shiftware) or the included CD. Using the software, load the calibration that matches your transmission's configuration.

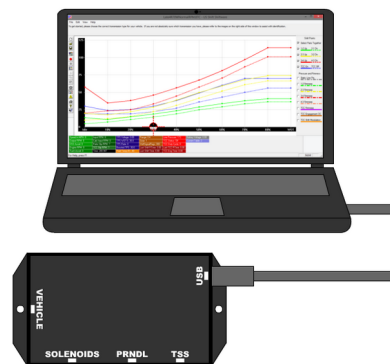

Step 8: Throttle Position Sensor Calibration

Whether you have electronic fuel injection or a carburetor, you will need to set the throttle position. To do this, use the throttle position calibration option on the built-in tuning interface. Turn the knob until "Setup Menu" is highlighted. Click the knob to enter the menu. The first item that will be highlighted is "TPS Setup". Click the knob to enter the TPS screen. It will show the current idle and WOT voltage values as well as the current throttle position sensor voltage. Press the knob again to enter the TPS setup menu.

To calibrate throttle position, the ignition should be on but the engine not running. For carbureted engines, make sure the choke is fully open and off the fast idle cam before beginning. In the TPS setup menu, highlight "AutoSet TPS" and click the knob. It will begin detecting the idle throttle position right away, so leave the pedal untouched.

Next, the display will show "Press Accel Pedal". Push the accelerator pedal all the way to the floor and hold it. After a few seconds, "Release Accl Pedal" will be displayed and you can release the pedal. If no errors occur, "AutoSet Success!" will display and the values will be shown to the left. If an error occurs during calibration, the display will show the error and abort calibration. If this happens, you can try running the calibration again. If errors continue, you may need to check your wiring for problems.

If needed, you can manually adjust TPS values by choosing “Adjust Idle” or “Adjust WOT” in the TPS setup menu. Once the TPS calibration procedure is completed, the values are permanently stored in the controller and will be active for every tune written. TPS values displayed within individual tunes are then irrelevant. If you require TPS customization for individual tunes or are using a negative slope TPS, then the TPS values stored in the controller can be reset by choosing “Reset TPS” from the TPS setup menu. Our provided tuning software, Shiftware, can then be used to calibrate TPS values for specific tunes.

Possible TPS Calibration Errors:

Pedal Not Pressed / Acc Pedal Not Held

The throttle wasn't pushed or held at maximum long enough for the test to complete. Accelerator pedal must be held for 3 seconds and voltage must not drop more than 0.168V below the maximum recorded value.

Pedal Not Released

The throttle wasn't released within 5 seconds. The voltage must drop at least 0.96V below the maximum measured WOT value.

TPS V. Not Stable

The idle throttle position has changed values too drastically over the course of the calibration. The idle voltage is more than 0.6V greater than the lowest recorded value.

Error: TPS V. Low

The voltage is below the minimum allowed 0.2V during any of the tests.

M. Busy, Try Again

EEPROM is busy, so the TPS settings couldn't be written to it.

NOTES ON INSTALLATION



If any error messages or unexpected characters are displayed, refer to the troubleshooting section at the end of this manual for detailed explanations.

General Installation

The Quick 4 unit should be mounted within the passenger compartment of the vehicle in a protected location. Good mounting areas include under the dash, behind a kick panel, or under the seat, as long as the unit and wiring are not subject to damage.



Under-hood mounting is NOT possible with the Quick 4 unit. It is not waterproof or rated for under-hood temperatures.

Passenger compartment mounting is also necessary to provide easy access to the USB port, which is used to interface with a PC for programming and diagnostics, as well as the display and function control knob. For this reason, be sure to mount the unit in a way that gives easy access to the USB port, knob, and display. If you will be using a desktop PC for programming, install the unit so that it can be unplugged and moved easily.

All electrical connections should be made using 60/40 rosin core solder. Cover the connection with heat-shrinkable tubing for improved insulation and mechanical strength. Individual connector terminals can be connected using a “piggy-back” method, where the terminal is removed from the plastic connector housing to allow the new wire to be soldered on to the terminal atop the original wire. Two wires may be connected together by twisting them together longitudinally, soldering, then covering with the appropriate size heat-shrink tubing.

Before Driving the Vehicle

Start the engine and move the shifter through all positions, ensuring that the gear position and all sensor readings shown on the controller are correct. Most importantly, make sure that no error messages are shown on the Quick 4 display. It is a good idea to periodically check the Quick 4 display for errors as you drive, so it is wise to consider an accessible mounting location. If possible, perform a line pressure check to ensure that line pressure is correct at idle (typically 60 - 80PSI), and that it smoothly increases toward maximum (typically 190-240PSI) as the throttle position increases. If you have any questions about the installation or line pressure readings, please contact our technical support department.

Adaptation for Factory-Equipped Transmissions

It is possible to use the Quick 4 controller in a vehicle which was originally equipped with one of the intended transmissions. This could be done in conjunction with an engine management system upgrade that no longer supports the transmission. Use of the controller for this purpose allows flexibility in choosing the engine management system, in addition to the increased control, performance, and transmission durability afforded by Quick 4. If you retain the stock PCM/VCM, it can probably be modified or re-flashed to disable the transmission functionality.

Identifying the Terminals of an Unknown Throttle Position Sensor

This is a procedure for identifying the correct terminal connections of any potentiometer-style throttle position sensor (almost all three-terminal TP sensors). A DVOM or analog Ohmmeter is required.

1. Set the meter to resistance mode and set it to a scale that can read up to 10K or 20K Ohms (if it is not auto-ranging). Please keep in mind when setting up and reading the meter that "K" means thousands of Ohms. In other words, 15K Ohms is the same as 15,000 Ohms.

2. Connect the meter to two pins at a time while operating the lever or cam of the TPS. Watch the meter while rotating the sensor. Check all three pairs of pins until you find a pair that does not change resistance when you rotate the sensor. The two pins that do not change resistance are the fixed ends of the resistance element (+5V and ground). The remaining pin that did change is known as the "wiper". It is the moving contact that slides along the resistance element to give the varying voltage. This is the output terminal of the sensor and should be connected to our green wire (Vehicle pin 3).

3. Next, with the sensor at the idle or closed throttle position, measure the resistance between the wiper (output) and each of the end terminals (the two whose resistance did not change in step 2) of the sensor. The end terminal with the lowest resistance to the wiper (at idle) is the ground terminal, and should connect to the black main ground wire of the controller (Vehicle pin 16). The terminal with the higher resistance to the wiper is the 5 volt reference input to the sensor and should connect to the orange wire (Vehicle pin 11) in our harness.

General Guidelines for setting up Throttle Position Sensors

The linkage to a throttle position sensor should use most of the rotating range of the throttle position sensor. This can be adjusted by changing the ratio of the linkage. Also, please make sure that a small amount of the sensor's travel is being used at idle. You will want a TPS voltage at idle of at least 0.35 volts. This is done to allow the controller to detect problems with the TP sensor. For instance, if the sensor becomes disconnected or the linkage falls off, the TPS voltage will fall below the set idle threshold. If the TPS voltage goes below the idle threshold, the controller assumes that the TPS is bad and will switch to failsafe line pressure and default shift points. This is done to prevent damage to the transmission from low line pressure and will provide a safe "limp home" mode.

TRANSMISSION DIAGRAMS

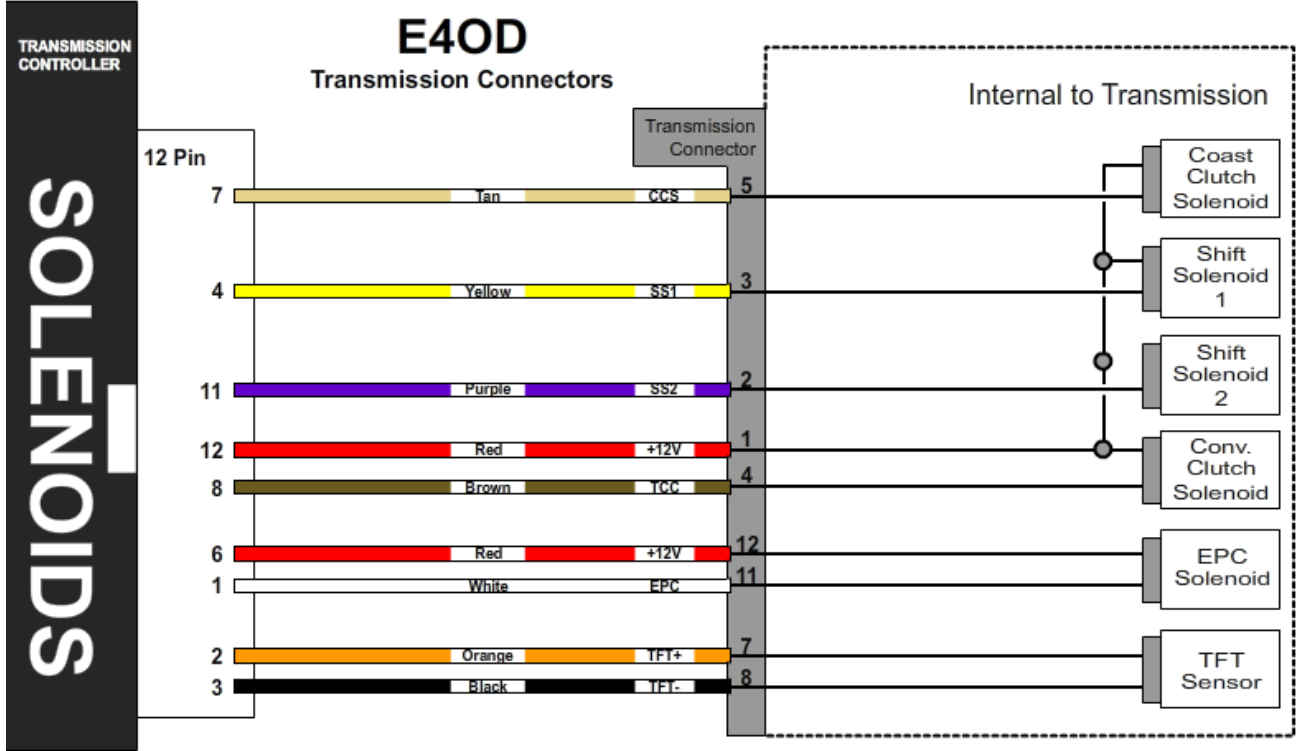

E40D

BACK VIEW

(FRONT PLUGS IN, WIRES COME OUT OF THE BACK)

Solenoids

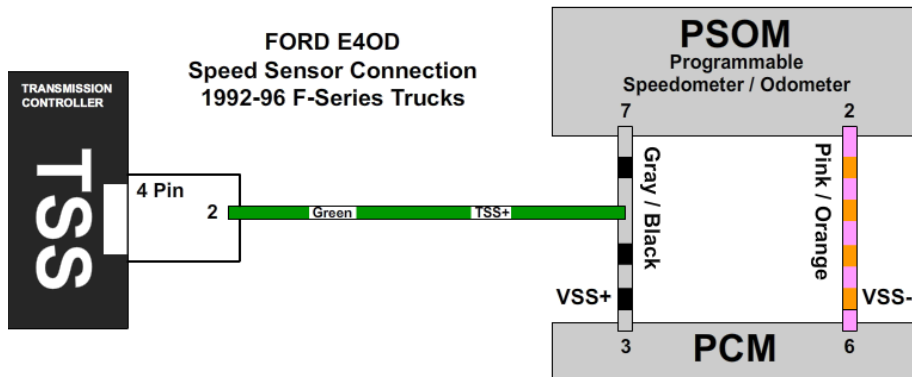
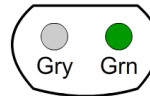
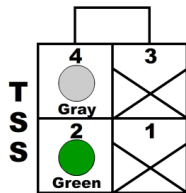
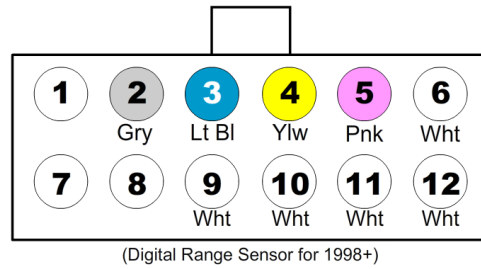
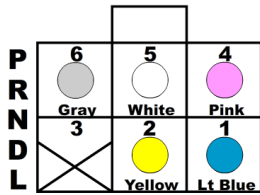
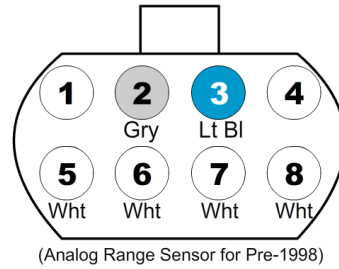
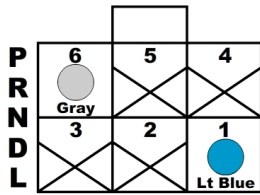
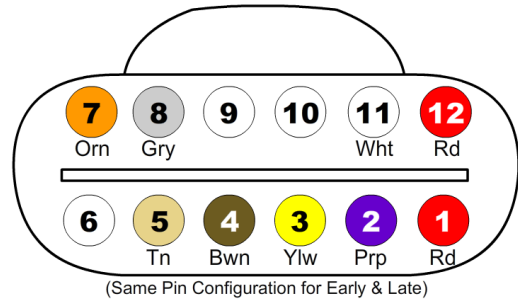
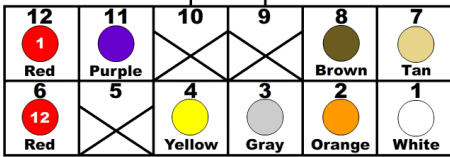

PRNDL AND TSS CONNECTORS

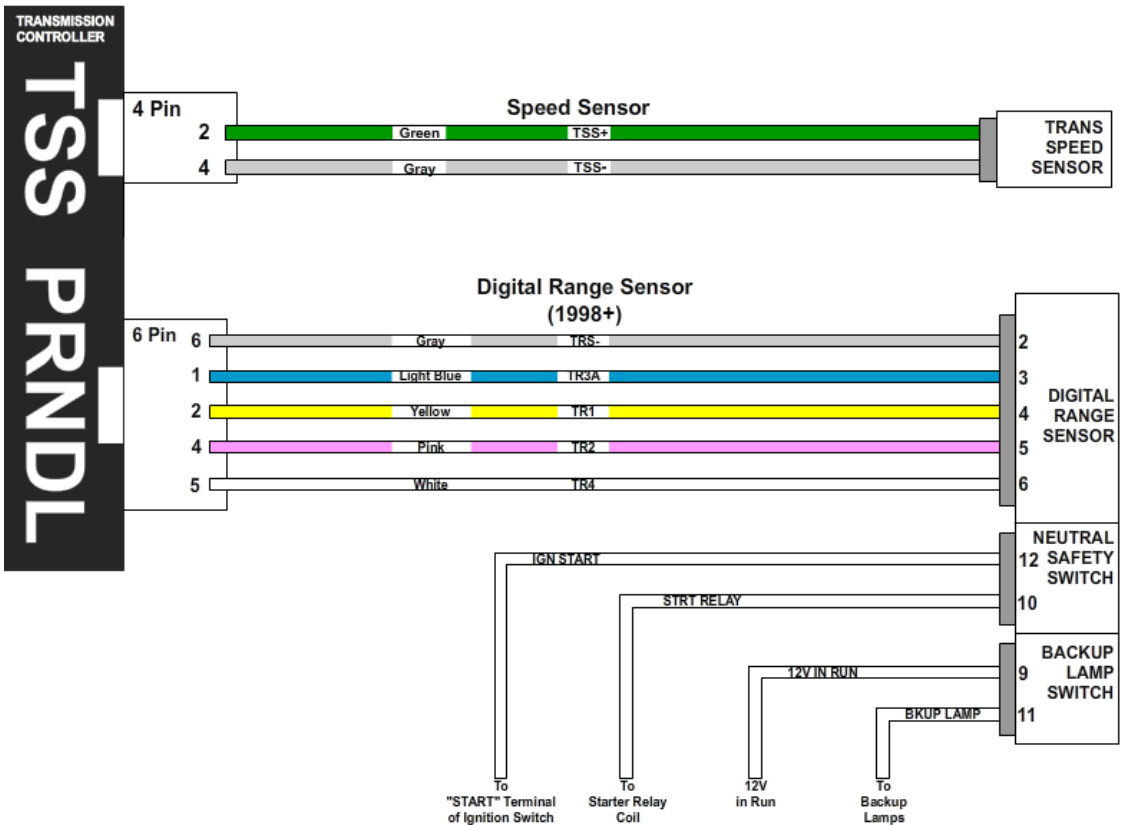
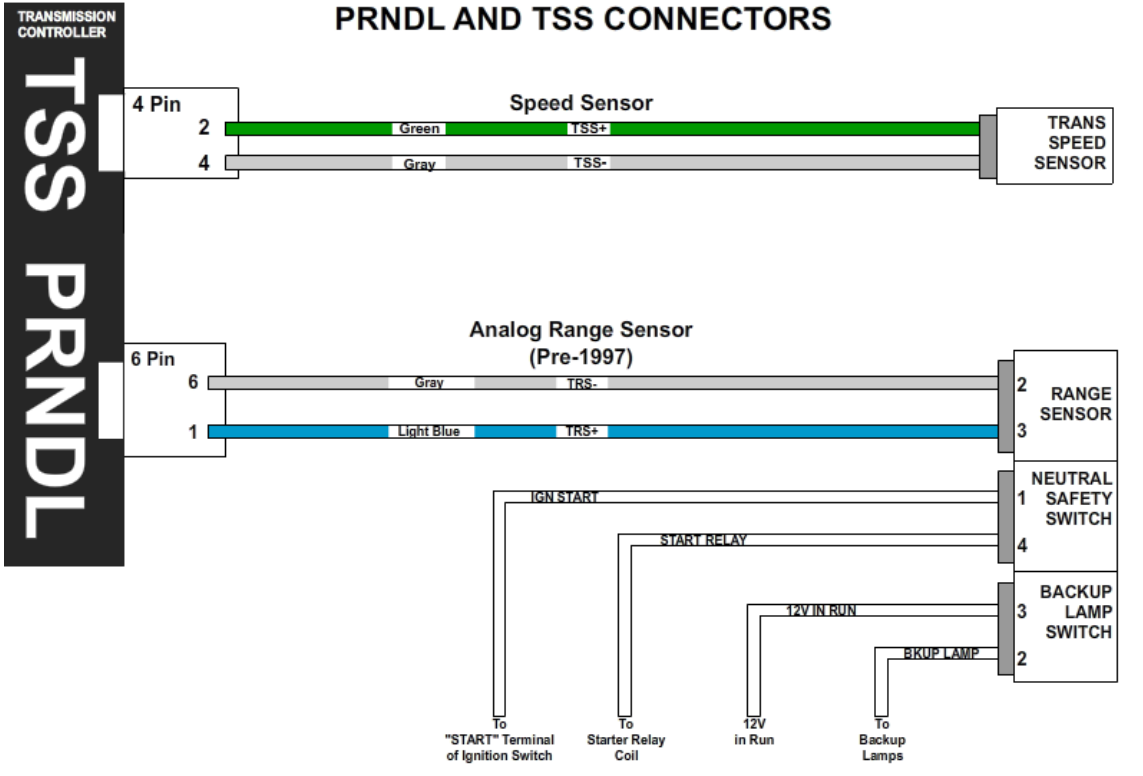

Ford Backup Lamp Connection Details

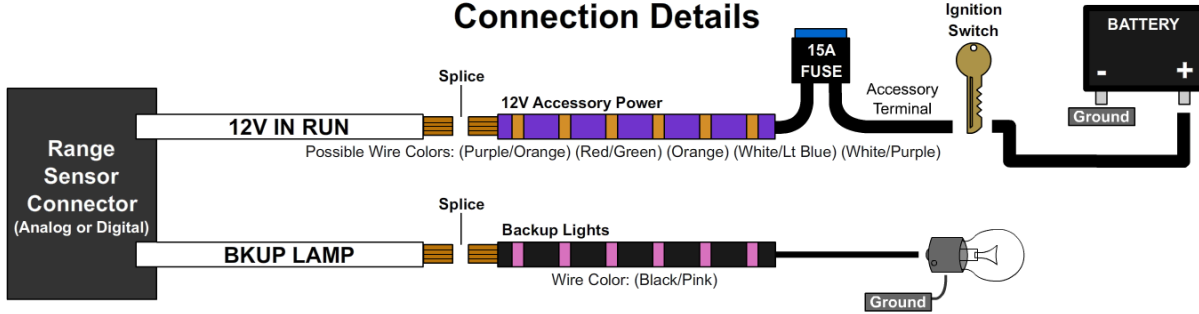

Ford Neutral Safety Switch Connection Details for Traditional Fender-Mounted Starter Relay

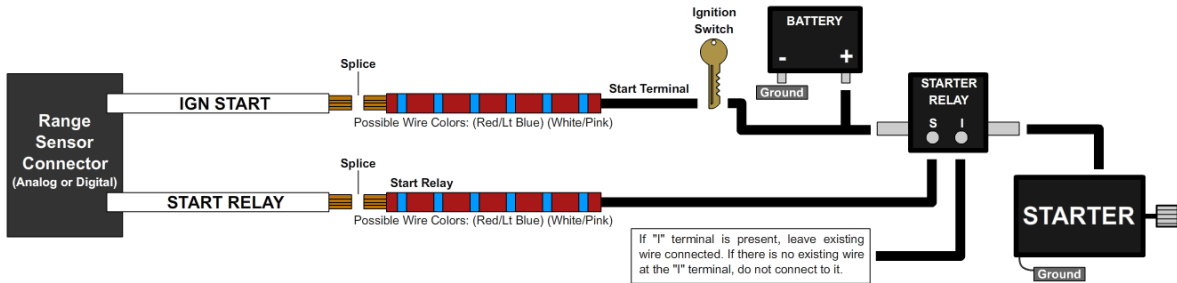

Ford Neutral Safety Switch Connection Details for Traditional Fender-Mounted Starter Relay with Solenoid-Style Starter

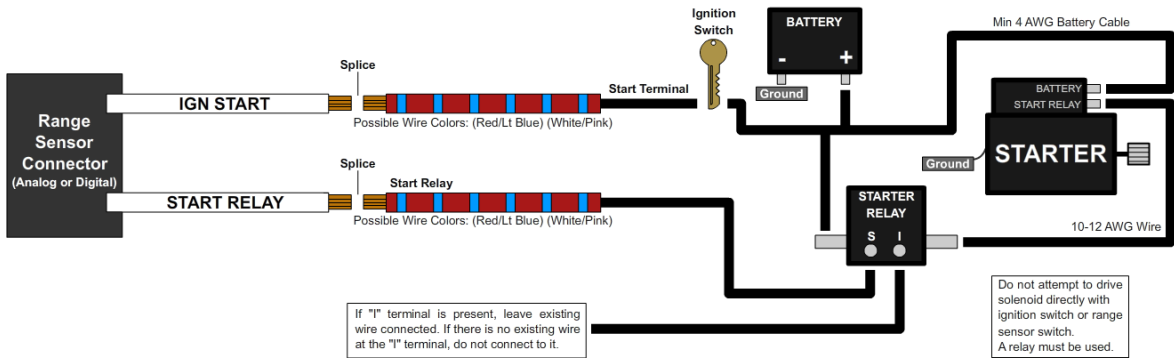

Ford Neutral Safety Switch

Connection Details for ISO or "Bosch" Mini-Style Starter Relay with Solenoid-Style Starter

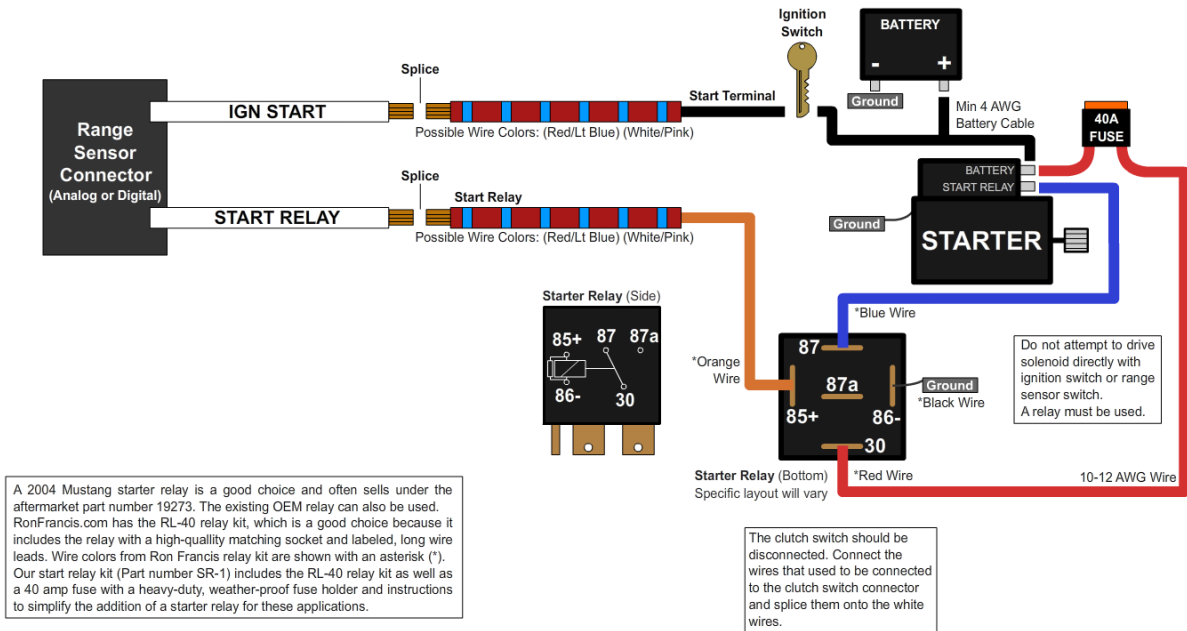

Ford Neutral Safety Switch

Connection Details for Manual to Automatic Conversion (for vehicles that were originally equipped with a clutch pedal starter interlock switch.)

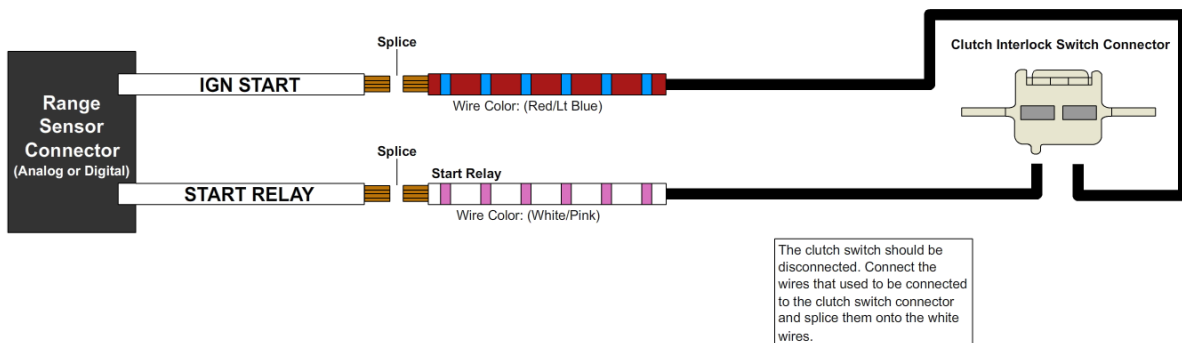

OPTIONAL FEATURES

MULTI-TUNE

This feature allows completely different calibrations to be used for the transmission at any time. The table selection switch can be a latching type switch (maintained toggle switch, latching push-button, etc.) or a momentary type switch (spring-loaded push-button switch, spring-loaded toggle switch, etc.) which applies ground to the table select input at Vehicle connector pin 5 when turned on. When a latching switch is used, it can only be used to switch between two tables. When the latching switch is activated, the controller will use the secondary calibration table (normally table 2), and it will run off of the primary table (normally table 1) when the switch is off. A momentary switch will cycle through all of the tables in use (1-2-3-4-1...). The Table Selection input may also be connected to a nitrous oxide system to provide an alternate calibration for use when the nitrous system is engaged. Other uses for this input include a “Sport/Economy” switch or a “Normal/Aggressive” switch. Whenever the table state is changed, the table indicator on the controller’s display will be updated accordingly.

There are alternative table select input methods that can be used. You can hold the O/D button for 2 seconds, single-click the controller knob while at the status screen, or attach a latching or momentary switch to the brown wire (pin 4). This would free up the purple wire (pin 5) to be a low-range selection switch.

Different modes can be selected in the tuning software which will select different tables for different situations. For example, “Select Tables Using Only 4WD Mode” will use table 1 in 2WD and 4WD high range, with table 2 for 4WD low range (Tables 3-4 will be used for the second and third low ranges, if equipped) If a switch is connected to the table select wire, “Select Tables Using Switch and 4WD Mode” chooses tables 1 or 2 in 2WD mode and table 3 or 4 in 4WD (depending on switch position).

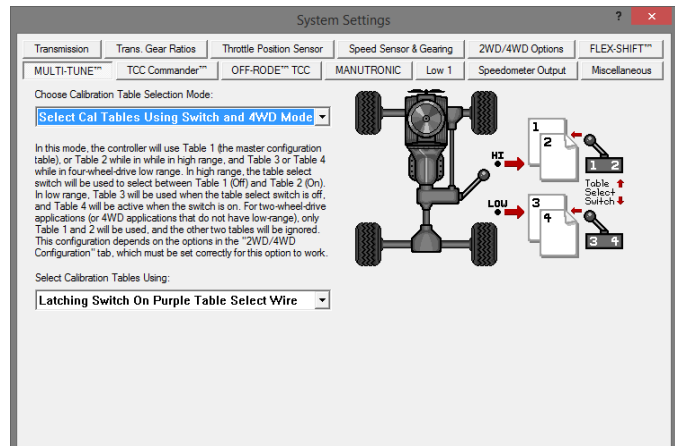

“Select Tables Using O/D On-Off Mode” will choose the table according to the Overdrive switch. O/D On will use table 1, O/D Off will use table 2, and Manual mode will use table 3 (if enabled).

4x4 Low Range Detection

Low range detection can be enabled if you want the controller to switch to an alternate calibration table when 4x4 low range is engaged. Configure the options in Shiftware under the “2WD/4WD Options” and “Table Select” tabs in the settings window. For example, 4x4 low range detection can be enabled so that when ground is applied to pin 5 (purple) of the vehicle harness, the controller will switch to table 2. Other options include holding the O/D switch for 2 seconds or single-clicking the controller knob to enable 4x4 low range calibration. Up to 3 low range ratios can be used. When low range is engaged, “LO”, “L2”, or “L3” will display beside speed on the built-in display. (Firmware 6.0d or higher required.)

Speedometer Output

We have provided an adjustable speed signal output on the tan wire on pin 12 of the vehicle connector that can be used to drive an electronic speedometer. Use of this output signal is not necessary, but it can be helpful if your speedometer can not be driven correctly from another source. This signal can also be corrected for different gear ratios and tire heights, so it can be very useful in some applications. The speedometer output signal is provided as a 12 Volt square wave or 5 Volt AC signal. The speedometer output modes can be selected via the built-in tuning interface in Setup Menu>SpeedoOut or in the tuning software. After entering the SpeedoOut menu, the current mode and ratio will be displayed. Push the knob to configure speedo out options. You can choose between 5V AC, 12V Pulse, Disable, Replicated, Adjustable, and Reset SPO. After making your choice, you can then fine tune the speedometer ratio using the knob. Choosing replicated will provide an amplified and squared replica of the speed sensor signal on the speedometer output. Reset SPO will clear all saved data for the speedometer output and revert to using values from the tune.

The speedometer output is adjustable and is essentially the electronic equivalent of a ratio corrector gear box for a mechanical speedometer. When adjusting the speedometer output, the correction factor is entered as a decimal number. The correction factor is the frequency ratio of the speedometer output frequency to the speed sensor frequency. This number can be easily adjusted to synchronize the vehicle speedometer to a GPS or other instrument. If you have a 4WD transfer case with low range capability and want the speedometer to be accurate while in low range, you will need to adjust the speedometer ratio in both high and low range in Shiftware and save a tune for high range and a tune for low range or multiple low ranges. ResetSPO will allow you to use the tune values.

In some cases, such as driving the input of an engine control ECU, the 0-12 Volt square wave signal will not be able to properly drive the device that it is connected to. This is because some devices are only designed to accept an input signal from a variable reluctance (magnetic coil) sensor. Because of this, they may expect the input signal to swing below ground (0 Volts). To drive this type of input, use the 5 Volt AC signal mode. In this mode, the driven device will see a -2.5V to +2.5V signal.

Shift-in-Progress

The shift-in-progress output is used to implement torque management functionality during shifts. When a shift is occurring, this output will be pulled to ground as a signal to the engine management system or ignition timing control device to reduce torque by managing ignition timing, throttle plate angle, boost pressure, or, for diesel engines, fuel. In some cases, a "pull-up" resistor to 5V or 12V may be needed to provide the proper input to the controlled device. Please contact US Shift tech support if you have any questions regarding the connection of this signal.

Engine RPM Signal Input

The engine RPM signal input on the yellow lead (pin 7) can be connected to a digital tachometer output from an engine computer or the tachometer output from an MSD ignition or similar CDI (Capacitive Discharge Ignition) system, but NEVER to the coil outputs of a CDI system like MSD.

For breaker points (or conventional electronic ignition systems such as GM HEI, Ford Duraspark or TFI), it can be connected to the coil negative terminal. For this configuration, add the supplied 47K Ohm resistor (yellow, violet, orange, and gold bands) to the yellow lead (pin 7) in-line with the tachometer signal. The correct setting will need to be set in the tuning software under Settings>Speed Sensor & Gearing.

For COP (Coil on Plug) ignition systems that do not have a conventional tachometer output (such as later Mustang engines), one of the coil trigger wires can be used, but the update rate will be slow. A better approach for such applications would be to use a tachometer adapter such as the AutoMeter 9117. DO NOT run the engine RPM signal wire in the same wiring harness as the speed sensor as this can cause interference.

Overdrive On-Off Switch

The Overdrive switch can be used to turn overdrive on or off. The switch can be a latching switch (toggle switch, latching push-button, etc.) or a momentary type switch (spring-loaded push-button switch, spring-loaded toggle switch, etc.) connected to +12v ignition-switched power and pin 4 (brown) of the vehicle harness. (The tan wire on pin 12 is for VSS output and shouldn't be confused with the brown wire on pin 4 for the O/D switch.) A momentary switch is needed to use more than 2 states. Optionally, you can add an O/D indicator lamp between +12v ignition-switched power and pin 2 (white) of the vehicle harness. This lamp will normally light up when overdrive is off. Also, without adding a switch, a single-click of the controller's knob can turn overdrive on and off. This setting can be configured under the "Flex-Shift" tab of the tuning software. Whenever the O/D or manual state is changed, it will be reflected in a change of the PRNDL indicator on the home screen display (e.g. PRNO21 will change to PRND21 or PRN321).

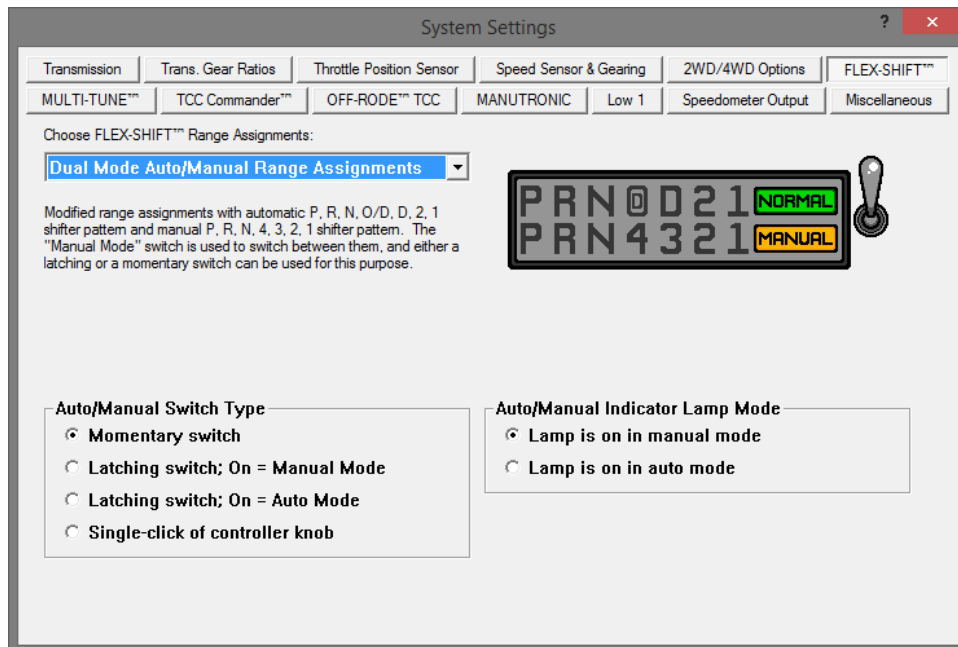

The FLEX-SHIFT Settings window. O/D settings are at the bottom.

To use an LED bulb for the O/D light (without built-in resistors for 12v), connect the cathode (-) lead to the white wire on pin 2 of the vehicle harness and the anode (+) lead to +12v ignition-switched power. Put a resistor in series on either side. We recommend using a 1.2k Ohm resistor, but you can use one with a lower resistance to make the LED brighter or one with a higher resistance to make it dimmer. It's best to stay above 1k Ohm to protect the LED. A 1/4w resistor or higher is recommended.

OVERDRIVE OFF LED LIGHT

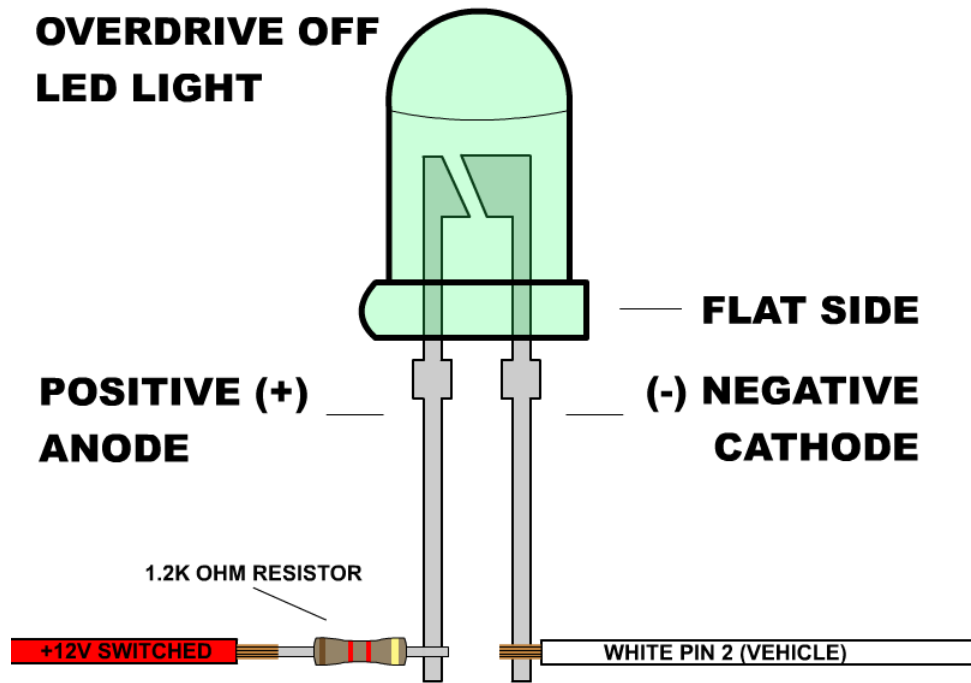

TRANSMISSION CONTROLLER

VEHICLE

OPTIONAL FEATURE CONNECTIONS

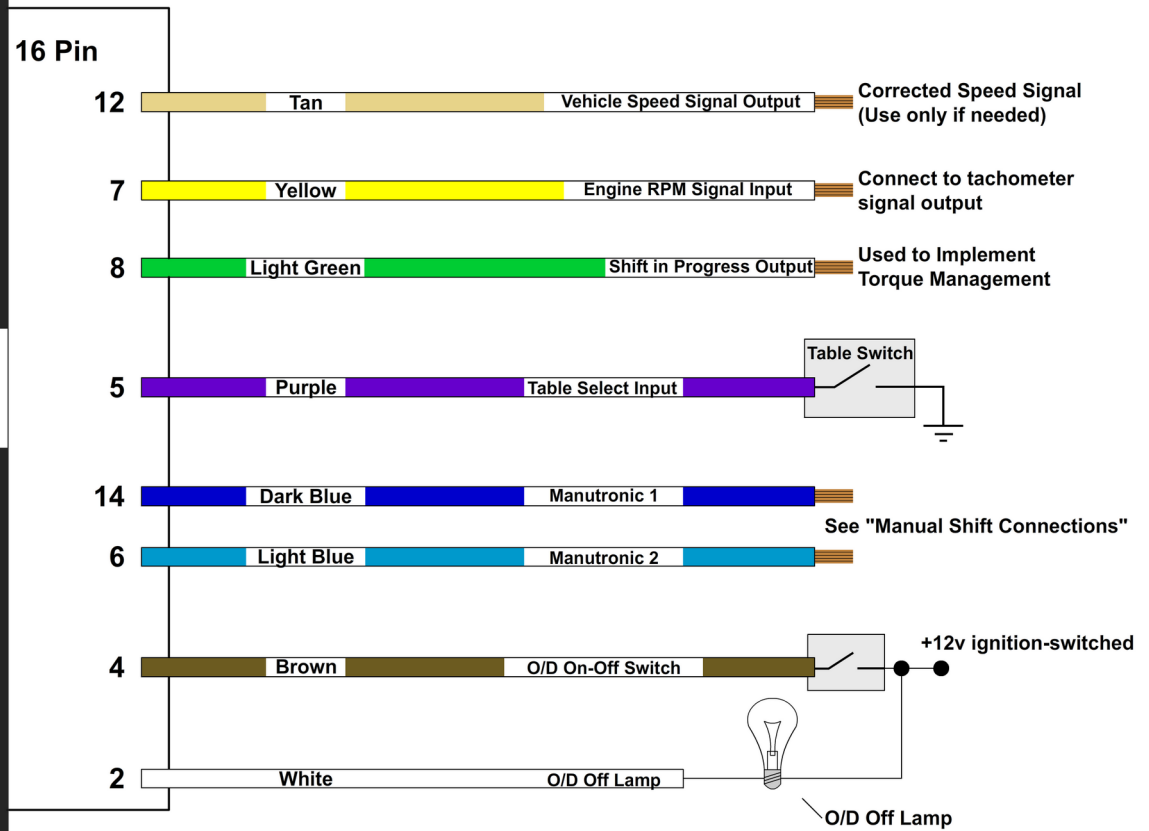

MANUAL SHIFT CONNECTIONS

Manutronic Overview

If connected and enabled the ManuTronic feature will allow manual selection of all forward gears using paddles, buttons, or another type of switch. With ManuTronic engaged, a brief press of the **UPSHIFT** button will change to the next higher gear, while **DOWNSHIFT** will change to the next lower gear. ManuTronic also has a safety feature which inhibits downshifting if the engine RPM is too high, which prevents over-revving of the engine due to a driver's error.

Ford Cruise Buttons with Cruise Module

For this configuration, you will need to solder the Dark Blue wire (Pin 14 on the Vehicle Connector) to the Blue / Black striped wire that connects the steering wheel buttons to the cruise module. (Follow the guidelines for soldering found in the "General Installation" section.) The Light Blue wire is not needed for this configuration. Be sure to use the correct settings in Shiftware. To enable Manutronic, double-click the CRUISE OFF button. Press ON or OFF once to disable it.

Connecting Manutronic to Ford Cruise Buttons with Cruise Module

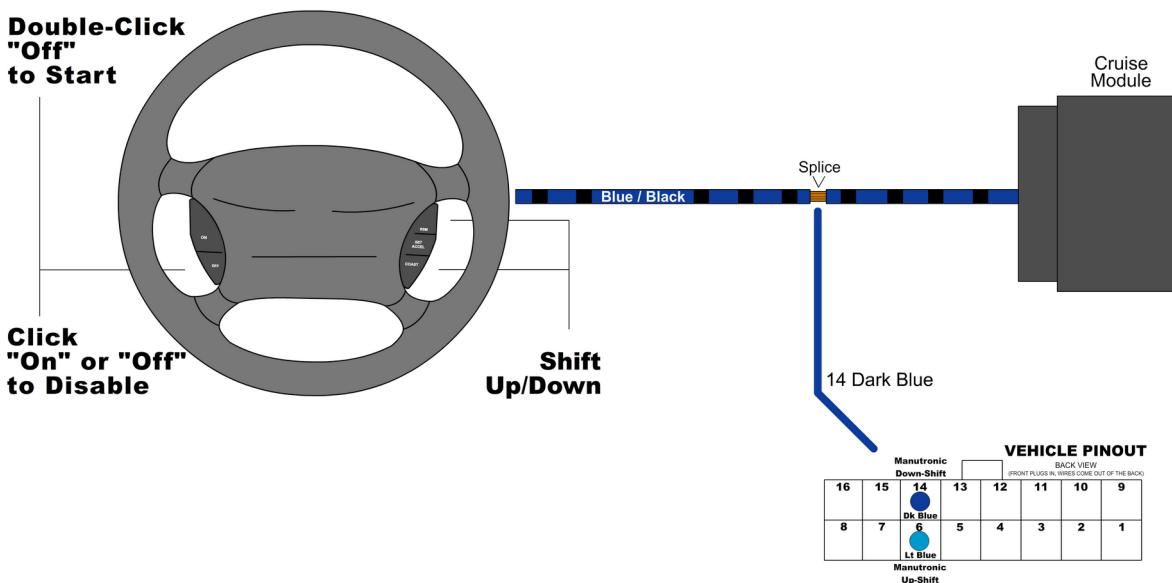

Ford Cruise Buttons without Cruise Module

For this configuration, you will need to connect the Dark Blue wire (Pin 14 on the Vehicle Connector) to the steering wheel buttons. (Follow the guidelines for soldering found in the “General Installation” section.) The Light Blue wire is not needed for this configuration. To enable Manutronic, double-click the CRUISE OFF button. Press ON or OFF once to disable it.

Connecting Manutronic to Ford Cruise Buttons without Cruise Module

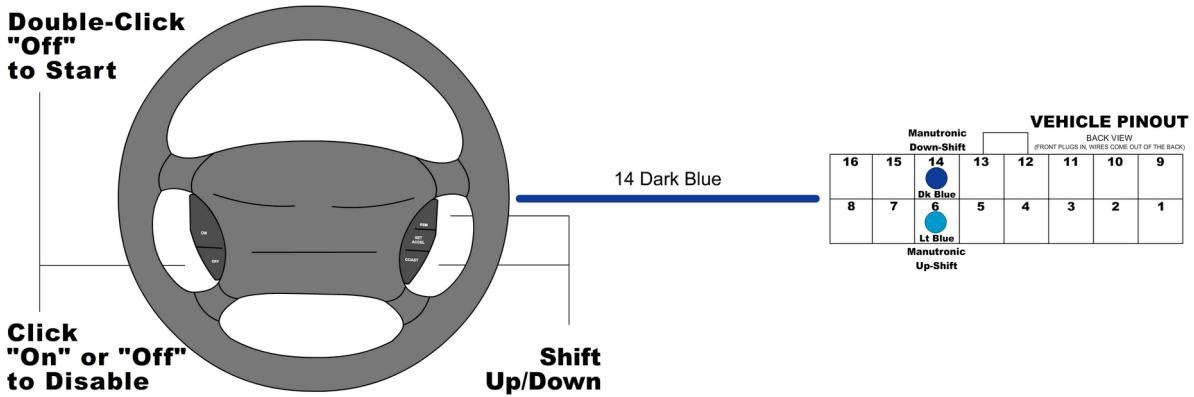

Shift Buttons with Latching On / Off Switch

For this configuration, you will need to connect the Dark Blue wire (Pin 14 on the Vehicle Connector) to your down-shift button (momentary) and connect the Light Blue wire (Pin 6 on the the Vehicle Connector) to your up-shift button (momentary). To connect the on / off switch (latching), solder the switch's wire onto the Dark Blue down-shift wire with the included 680 Ohm resistor between them. (Follow the guidelines for soldering found in the “General Installation” section.) Remember that the correct settings must be used in Shiftware. Manutronic will be enabled when the toggle switch is turned on and disabled when it is turned off.

Connecting Manutronic to Push Buttons with Latching On/Off Switch

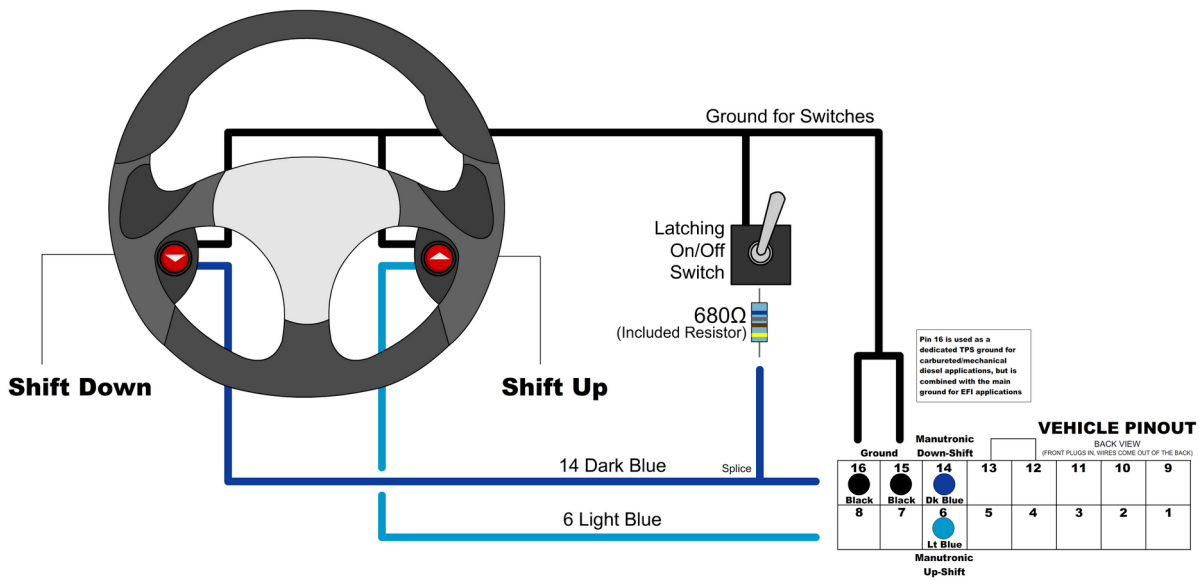

Shift Buttons with Momentary On / Off Switch

For this configuration, you will need to connect the Dark Blue wire (Pin 14 on the Vehicle Connector) to your down-shift button (momentary) and connect the Light Blue wire (Pin 6 on the the Vehicle Connector) to your up-shift button (momentary). To connect the on / off switch (momentary), solder one side of the switch onto the Dark Blue down-shift wire and the other side to the Light Blue up-shift wire. (Follow the guidelines for soldering found in the “General Installation” section.) Remember that the correct settings must be used in Shiftware. To enable Manutronic, press the On/Off button once and do the same to disable it.

Connecting Manutronic to Push Buttons with Momentary On/Off Switch

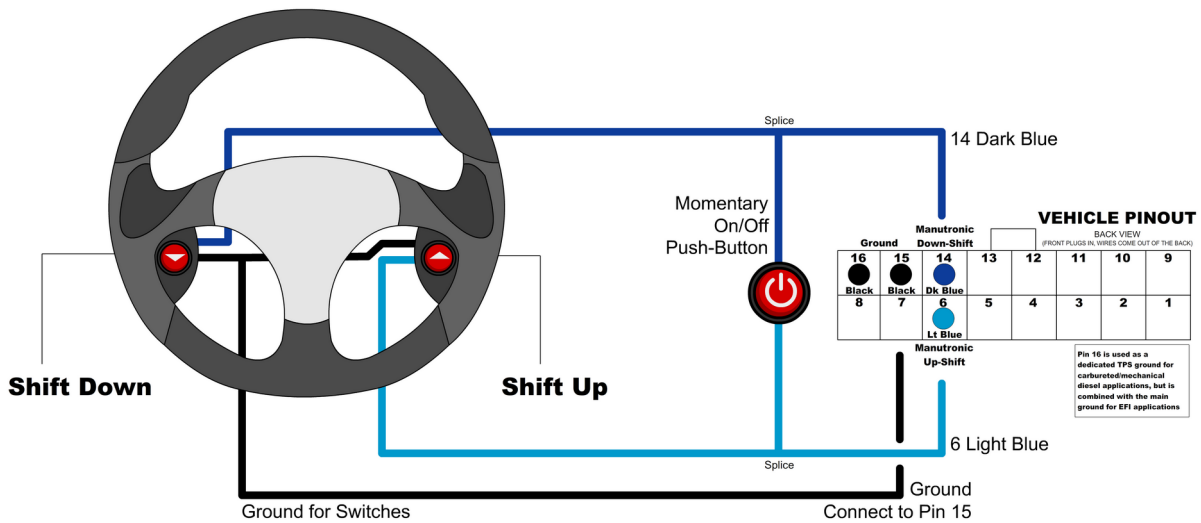

Twist Machine Shrifter™

For this configuration, you will need to connect the Dark Blue wire (Pin 14 on the Vehicle Connector) to channel 2 of the receiver and connect the Light Blue wire (Pin 6 on the Vehicle Connector) to channel 1 of the receiver. You can use either a momentary push-button on / off switch or a latching toggle on / off switch. (Refer to the previous two sections on how to install and use the on / off switch.) Remember that the correct settings must be used in Shiftware.

Connecting Manutronic to Shrifter™ Paddles

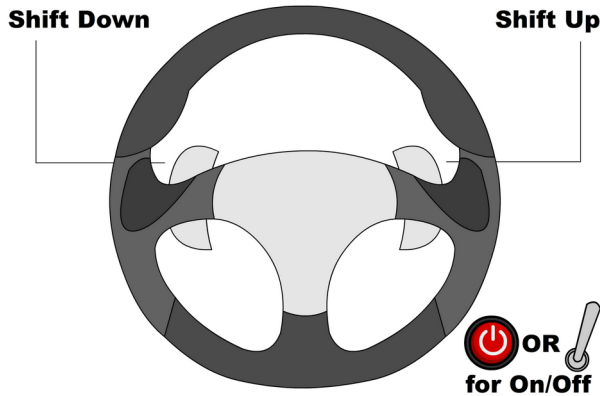

*Both types of On/Off switches (latching & momentary) can be used with the Shrifter. Refer to the previous diagrams for details on connecting an On/Off switch.

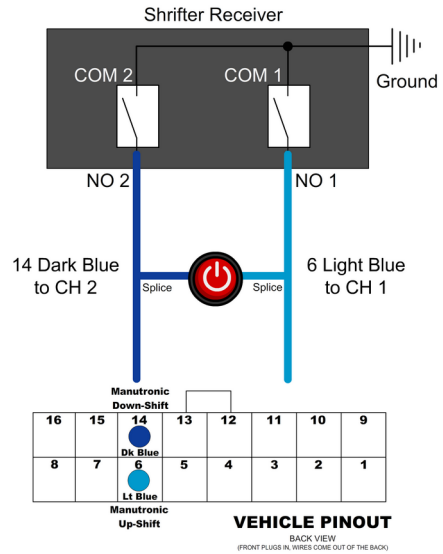

Lokar Shifter

For this configuration, you will need to connect the Dark Blue wire (Pin 14 on the Vehicle Connector) to the blue down-shift wire and connect the Light Blue wire (Pin 6 on the the Vehicle Connector) to the blue up-shift wire. To connect the sport mode switch, solder the sport mode switch's red wire onto the Dark Blue down-shift wire with the included 680 Ohm resistor between them. Then, solder all 3 black wires to the controller's ground connection (Pins 15 + 16 on the Vehicle Connector. Follow the guidelines for soldering found in the "General Installation" section.) Remember that the correct settings must be used in Shiftware.

Connecting Manutronic to Lokar Shifter

VEHICLE PINOUT

BACK VIEW
(FRONT PLUGS IN, WIRES COME OUT OF THE BACK)

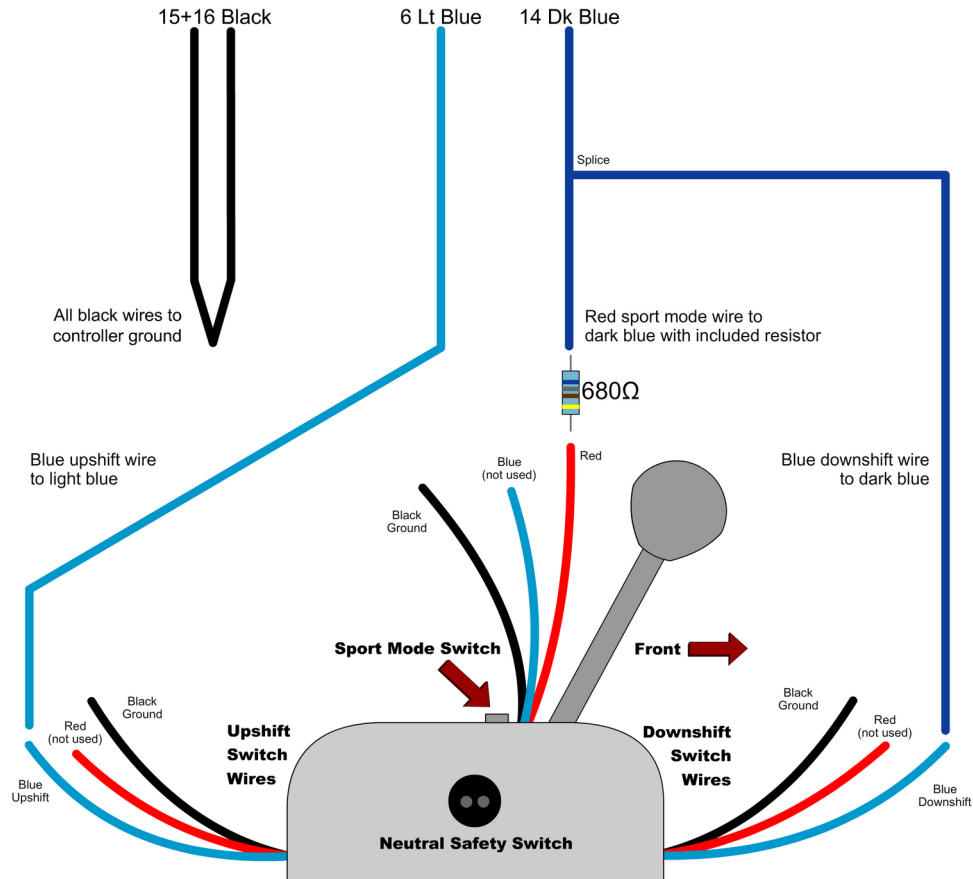
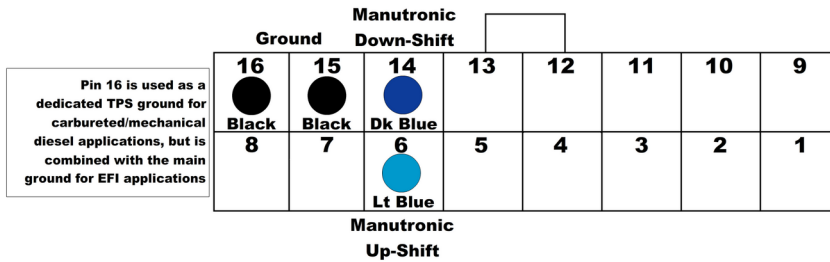

BUILT-IN DISPLAY / REMOTE DISPLAY

The second generation built-in display of the Quick 4 is easier to use and more intuitive. It provides useful information, such as current speed, gear, transmission temperature, and TCC lock status, along with any fault messages. Using the menus, you'll be able to access many of the same options found in Shiftware. The remote display takes the same menus utilized in the built-in display and separates them from the controller, allowing for easier mounting and access, in addition to a 30% larger screen.

BASIC OPERATION

While the home screen is shown, you can turn the function knob in either direction to bring up the main menu. The highlighted phrase in the center of the screen is your selection. When you've found the menu item you wish to access, push the knob down to click it. Sub-menus work the same as the main menu. Each sub-menu has an EXIT option which will return you to the previous menu or the home screen.

HOME SCREEN

Shows real-time transmission information such as speed, current commanded gear, transmission temperature, selected calibration table, TCC lock, PRNDL position, and any active faults. When low range is engaged, "LO", "L2", or "L3" will be shown beside speed. "KEY OFF" will show in the PRNDL location if ignition is off and the controller is being powered by USB. "Error" will show in the PRNDL location if there is a PRNDL sensor error. Fault messages will be shown in the center of the display and will cycle through them if there are multiple errors. While no errors are present, the home screen will automatically switch to normal mode for easier visibility. (Remote display specific options will be discussed later in this section.)

Built-in Display Normal Screen Mode

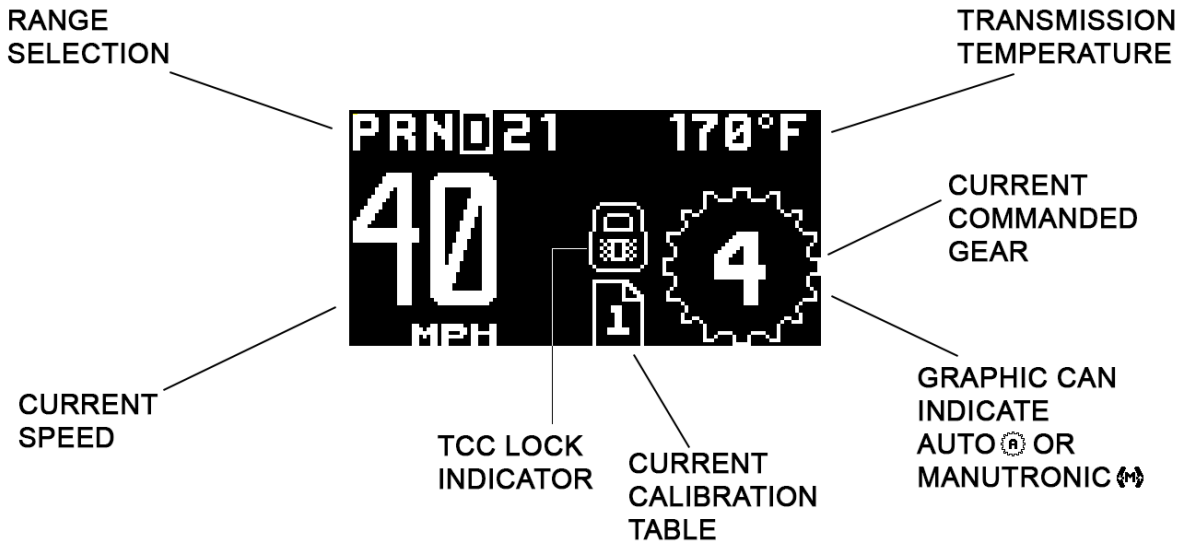

Built-in Display Error Screen Mode

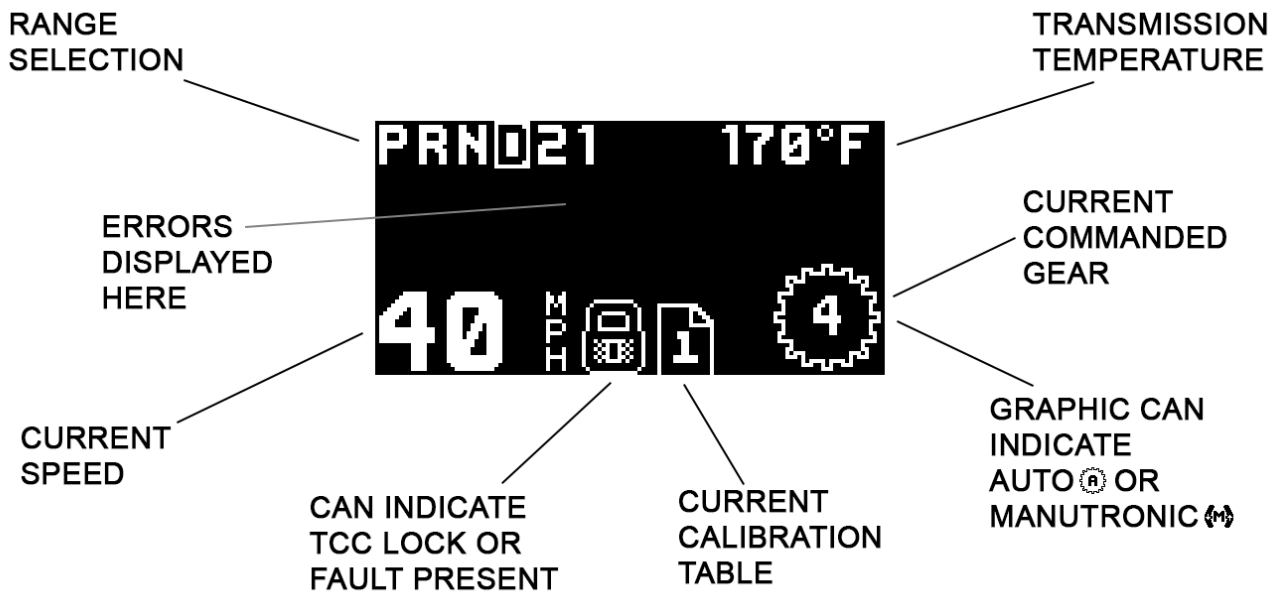

Remote Display (Shown with Normal Screen Mode)



Remote Display Large Screen Mode

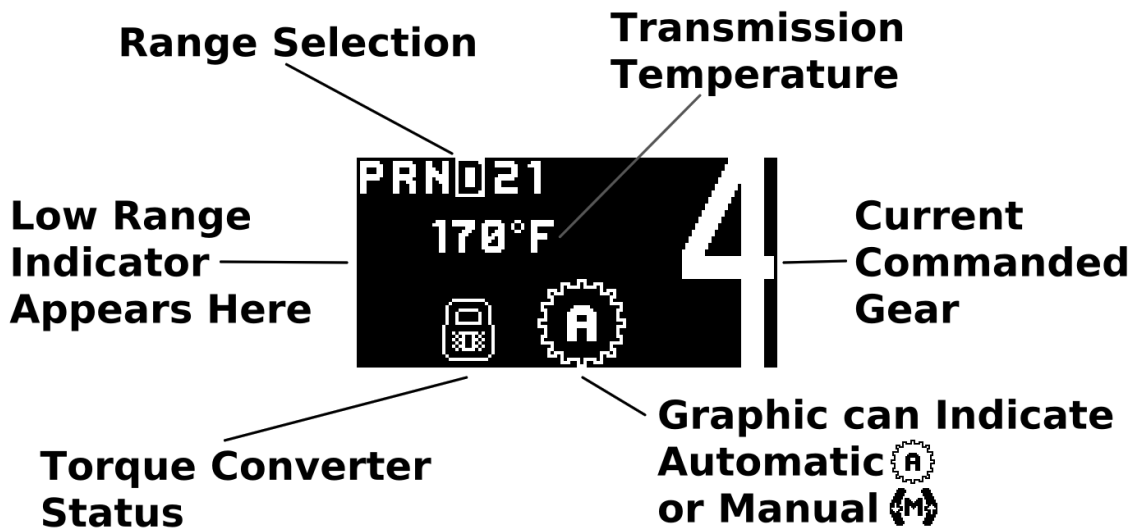

REMOTE DISPLAY

Mode Button: This button has the same functionality as the O/D or Manual Mode switch. Refer to the Optional Features section for more information.

Table Button: This button has the same functionality as the Table Select input, allowing you to swap calibration tables on-the-fly. Refer to the Optional Features section for more information.

Control Knob: Turn left or right to scroll, push down to click.

Light Sensor: Adjusts display brightness depending on how much sunlight is present. Auto-Dim setting can be adjusted within the “Display Setup” menu. Make sure that nothing blocks the light sensor or the display will always be dim.

Mode / Table LEDs: These can be adjusted to either be off all the time, on all the time, and with different color options for each mode or table within the “Display Setup” menu.

MAIN MENU

Home Screen = Chooses the home screen as your default view.



Info Screen = Shows current sensor values, replacing the home screen as default view. Info includes TPS voltage and percentage, battery voltage, commanded pressure in PSI, and engine RPM.

Setup Menu = Use this menu to choose preliminary settings essential for operating the vehicle.

Tune Menu = The tune menu can be used to make adjustments to shift timing, shift feel, and torque converter clutch settings.

Diagnostics = The diagnostics menu provides access to advanced troubleshooting data and procedures.

Table Select = The table select menu allows you to choose which calibration table you want the controller to use or use a toggle switch or other selection method to choose. (Table selection method can be changed via Shiftware’s settings tab.)

Tutorial = Plays a demo on the display with instructions on how to use the interface. It can be interrupted by turning the knob, which will show the main menu. The tutorial will continue to play until you select home screen, info screen, or turn off the vehicle.

Display Setup (Remote Display Only)

Brightness = Adjusts the remote display's brightness.

Auto-Dim = Adjusts auto-dim sensitivity from OFF to high sensitivity.

Mode LED Color = Chooses between OFF, Red, Green, or Mixed for each mode. In mixed mode, the knob can be rotated to create a custom blend of the two.

Table LED Color = Chooses between OFF, Red, Blue, or Mixed for each table. In mixed mode, the knob can be rotated to create a custom blend of the two.

Home Screen Type (HMSCR TYPE) =

Chooses between large screen for manual only (Large Manu), always use large screen (Always Large), or always use normal screen (Always Norm). Large Screen is a new option for the remote display which provides a large current gear indicator, but eliminates the MPH display. It is especially useful for Manutronic or paddle shift mode.



Exit = Returns to the main menu.

Display Off = Keeps the screen off until you turn the knob. The display will continue to switch off until you select home screen, info screen, or turn off the vehicle.

SETUP MENU

TPS Setup = Clicking this will take you to the TPS Setup menu, which shows the idle and WOT settings as well as the current voltage of the TPS. Clicking once will open the menu. Clicking AutoSet TPS will take you through the steps to calibrate your throttle position sensor settings. You can also manually adjust these settings by clicking Adjust Idle or Adjust WOT. Reset TPS will erase the saved TPS data from the controller, reverting back to the TPS voltages saved in the loaded tune file. See page 12 for more details.

Speedo Out = Provides configuration options for the speedometer output. See page 19 for more details.

Speed Sensor = This menu allows you to choose your speed sensor type and configure its details such as speedometer drive gear teeth, driven gear teeth, and pulses per revolution. Rotating the knob in this screen changes the speed sensor type. Available speed sensor types will vary depending on the current transmission type. If other options, such as speedometer gear teeth, pulses per revolution etc. are available for a specific sensor type, pushing the knob will bring up a menu that allows you to change the adjustment mode or to exit. If no options are available for the selected sensor type, pressing the knob will exit this screen and save the settings. After scrolling through all the speed sensor types, the last option is to reset the speed sensor settings. This will revert all of the settings for the speed sensor, axle ratio, and tire diameter back to the defaults from the currently loaded tune.

Axle Ratio = Allows you to input your axle ratio, which improves speed display accuracy in the home screen and will also will affect speed sensor calibration for certain types of speed sensors.

Tire Diam = Allows you to input your tire diameter, which improves speed display accuracy in the home screen and will also will affect speed sensor calibration for certain types of speed sensors.

Engine RPM In = Allows the adjustment of the engine RPM input configuration. This includes pulses per revolution and type of RPM sensor or signal. Turning the knob allows adjustment of pulse rate, while pressing the knob will bring up a menu of options including preset pulse rates, signal types, and the exit option (which also saves these settings).

TUNE MENU

Shift Points = Sets the RPM at which shifts occur for all shifts or each individual shift. Once you've chosen a shift to adjust, you will be presented with a menu showing 10% throttle, 40% throttle, and Wide Open Throttle. Under each is shown shift point RPM. You can adjust each throttle percentage individually. Changes won't be saved to the tune until you click "Save & Exit".

Firmness = Set shift firmness for all shifts or each individual shift. Once you've chosen a shift to adjust, you will be presented with a menu showing 10% throttle, 40% throttle, and Wide Open Throttle. Under each is shown a number representing firmness. You can adjust each throttle percentage individually. Changes won't be saved to the tune until you click "Save & Exit".



Tq Conv Cl = This takes you to the torque converter clutch menu, allowing you to adjust aspects of the TCC. This includes cruise gear, minimum RPM, and WOT gear. Changes won't be saved to the tune until you click "Save & Exit".

DIAGNOSTICS

Dyno Mode = Enable this mode if you are doing a dyno test. While enabled, you can use the knob to shift gears. Push the knob to access options, such as enabling torque converter clutch (TCC) activation above 1800 RPM, disabling the TCC, and exiting dyno mode.

*Please note that it is not safe to use this mode while driving.



Data Display = Allows you to see readings on the inputs and outputs, such as Solenoid Ohms and current, PRNDL values, and the voltage or status of various inputs, such as table select and manutronic. These screens will be helpful when using the troubleshooting guide or working with our tech support department. Please note that the solenoid current screen uses the knob to manually select the current gear, similar to dyno mode. This allows you to easily verify proper solenoid function in each gear.

Clear Learn = Clicking on this item will allow you to chose which learned data to clear. You might want to use this if something has changed with the vehicle or transmission to allow the controller to re-learn the data. The options are "TCC Learn", "Shift Timing", "All Learning", and "Exit".

Sys Info = Displays firmware and hardware version information as well as serial number (ID), copyright, and patent information.

Override = There are several options in this menu which are useful when troubleshooting.

Line Prs = Used to override line pressure manually. Use this only if you were instructed to do so by a Baumann Electronic Controls technician.

TCC Sol = Used to manually lock the TCC by holding the knob down. When released, the TCC will unlock. Doing this while idling in gear will usually cause the engine to stall if your transmission allows TCC engagement in first gear.

Mode Lamp = Used to test the overdrive or manual mode lamp. The lamp should illuminate when you hold the knob down.

SHIFTWARE

Introduction

In most cases, the Quick 4's built-in tuning menu will allow users to make all the modifications they'll need without connecting to a PC. However, using the Shiftware software allows you to modify the way your Quick 4 Transmission Control System behaves in greater detail. You can customize shift-points and advanced settings, monitor the Quick 4 in real-time, record detailed logs, and diagnose errors.

Setup

To create a calibration for the Quick 4, it is best to start with one of the standard calibrations which are included with the software. To load a standard configuration for your transmission, click the **Open**  button on the toolbar, then browse to the folder where the transmission calibration files are located. (Default location is C:\Shiftware\) The files are named according to the transmission and RPM range and have the .btc file extension. Choose the calibration file and click **Open**.

Once the calibration file is loaded, click the **System Settings**  button on the toolbar to check the settings and make sure that they are correct for your transmission. The System Settings window has several tabs within it. Click each one to see each section of settings specific for your transmission.

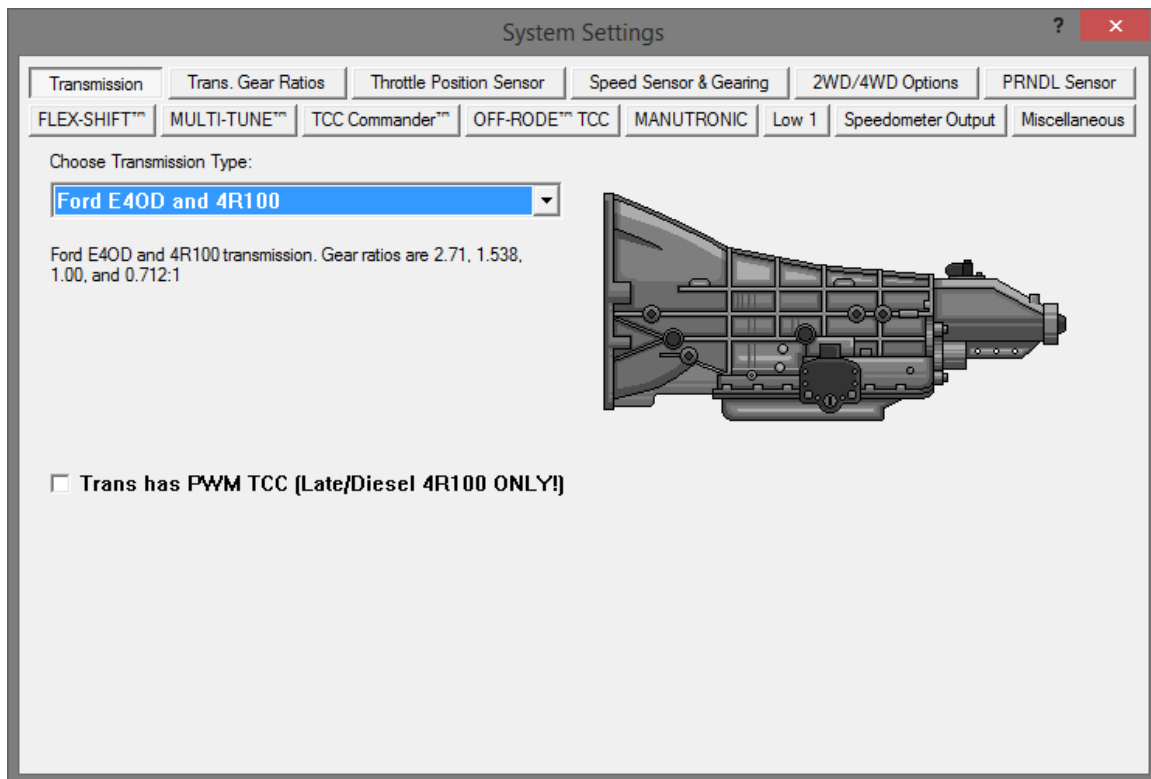

The System Settings Window

Customize

The main window is where all of the shift points and line pressure editing is done. The graph displays the up-shift and down-shift speeds in relation to throttle position for each shift. It also displays the line pressure & firmness curve in relation to throttle position. The line pressure curve is displayed in PSI, so the higher the curve, the more firm shifts will be. You can use the checkboxes on the right to turn on the curves for individual shift firmness and adjust them independently.

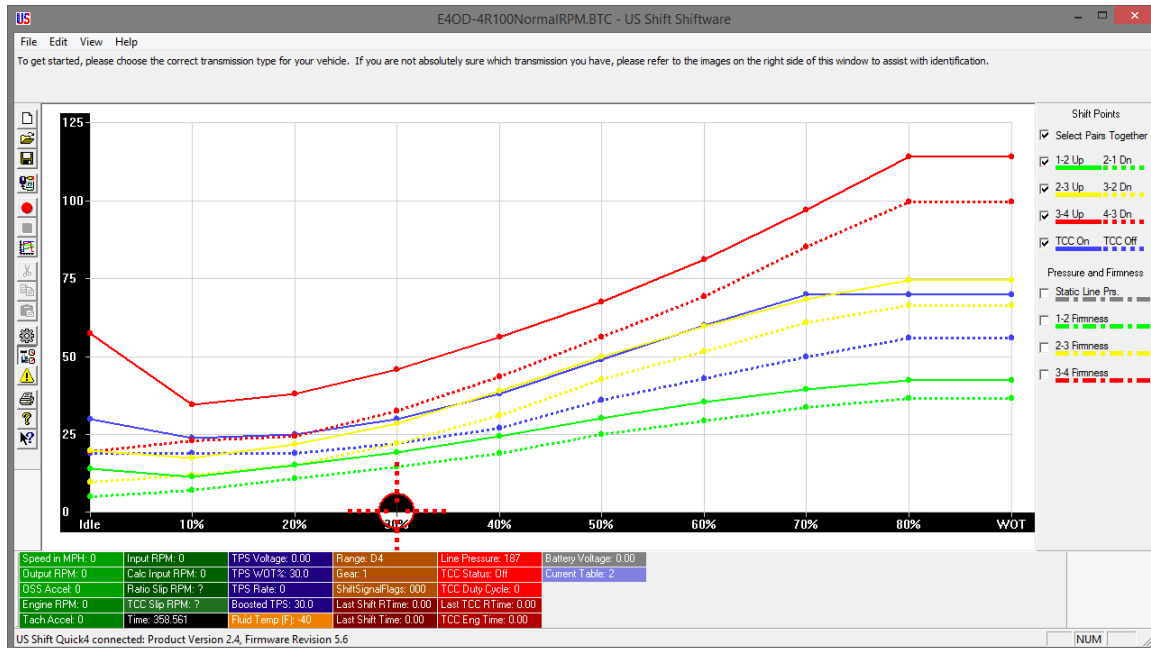

The Main Window

You can get help on anything by clicking the **Question**  button and then clicking on an item. This can be used in any area of the software. Pressing F1 will show help on whatever item is currently active. The help messages in the settings pages are transmission-specific and are more like getting professional advice than normal help tips.

The graph has ten points from left to right, 0 being idle and 9 being Wide-Open-Throttle (WOT). On the left side of the graph is the shift speed. When you hover over a graph point, you can also see the corresponding shift speed in RPM or the applicable unit values for items other than shift points. Click on a point in the graph to select it.

If **Select Pairs Together** is enabled, then the corresponding down-shift point will be automatically selected along with the up-shift point. This can be turned off by clicking the **Select Pairs Together** checkbox on the right. You can select multiple points by holding CTRL while clicking the points or a range of points by holding SHIFT and clicking the two points on each end. You can move between adjacent points using the LEFT and RIGHT arrow keys.

Once a point (or points) is selected, you can drag it with the mouse to raise and lower its value. A yellow box will appear in the graph telling you what the value of the point is.

Shift Timing Learning

By default, the Quick 4 will learn the shift and TCC timing characteristics of your transmission. It will complete a learning cycle over the first few hard-throttle passes and will use the learned data to optimize shifts. For learning to occur, the engine RPM input signal must be connected and functioning properly. During the learning cycle, you may notice unusual TCC operation. This is normal and will end once learning is complete. Once learned, the data will not change unless it is erased using the clear command on the controller's user interface, found in Diagnostics > Clear > Shift Timing. Clearing the data will cause another learning cycle to begin. This could be useful if the transmission is altered or upgraded in some way.

For optimum accuracy, learning should be done at the same transmission fluid temperature that it will be run at during normal operation. Once learned, shift point accuracy will only be limited by the consistency of your transmission's valve body.

To view a report on the learned data, connect the controller to a pc with Shiftware installed. Click **File**, then **Generate Diagnostic Report**. This will read the data from the controller and open the report in a browser window.



If you wish to disable learning, enter Settings in the tuning software and switch to the Miscellaneous tab. Uncheck the **Enable Learned Shift Timing** checkbox. This will stop the controller from using learned data, but will not erase the learned data. This would be useful if you plan to make changes to the transmission or are unable to complete a proper learning cycle.

Save & Load

Once you have created your calibration, you can save the file to your hard drive or an external storage device. To save, click the **Save**  button on the toolbar. Then, browse to the location where you want it saved and click **Save**. Use "Save As" under the FILE menu to leave the original file unchanged and create a new version. Type the desired filename and click **Save**. Files are saved with a .btc extension.

To load a calibration file, click the **Open**  button on the toolbar. Then, browse to the file and click **Open**.

Writing a Calibration to the Quick 4

For the changes you've made to take effect on the Quick 4 controller, you first must write the calibration to the unit. Connect the Quick 4 to your computer using a standard USB cord (Type A to Type B). Click the **Write Calibration**  button on the toolbar and a menu will appear. If you aren't using multiple calibrations, click the **All Tables** button to save the calibration to the controller. The Quick 4 can now be disconnected from the computer. (To use multiple tables, you can create a new calibration and choose one of the other table buttons when writing to the controller.) When the Quick 4 unit is disconnected from the computer, the **Write Calibration**  button will be grayed out.

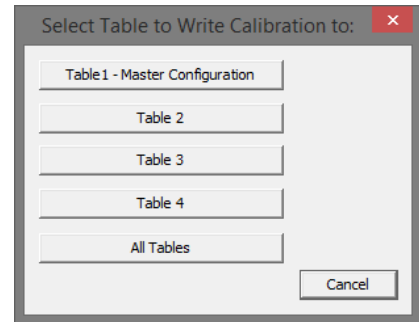

IMPORTANT INFORMATION

How to Avoid Errors

The Shiftware software gives you complete freedom and flexibility to customize your shifting calibration however you want. This freedom requires diligence to avoid errors.

It is *very* important that the up-shift and down-shift curves for a given gear do not cross. The up-shift point at any throttle position should usually be at least 15% greater than the down-shift point. For instance, if the 2-3 up-shift point at ½-throttle is 45MPH, then the 3-2 down-shift point should usually be less than 40MPH.

The “On-Off” differential between up-shift and down-shift points is called Deadband (also known as Hysteresis). The more deadband you use for your shift points, the more stable the system will be. Not using enough deadband can result in erratic shift behavior. Too much deadband will result in sluggish behavior due to a reluctance to down-shift.

Pay close attention to the interaction between different shifts. Overlapping the 1-2 and 2-3 shifts can cause skipped gears and other drivability problems.

Also note that torque converter slip at low speeds renders engine RPM values meaningless. It is usually desirable to have light-throttle shift points within a low RPM range. In this case, it is best to base light-throttle shift points on vehicle speed rather than engine RPM (as most auto manufacturers do).

TROUBLESHOOTING ERROR MESSAGES

WARNING! If the transmission does not begin to operate correctly within the first few feet of the road test, **STOP** immediately, check the troubleshooting guide, and call **Baumann Electronic Controls** if you need assistance. In some cases, just a few blocks of operation with low fluid pressure can destroy a transmission.

Error Messages

When the Quick 4 detects an error, it will show one of the following error messages on the home screen. If there are multiple errors, it will cycle through them on the home screen. Error messages can also be viewed in **Controller Fault Display** in the tuning software. History is cleared when the controller powers down completely (ignition turned off and USB cable removed from computer.) It is a good idea to periodically check the display for errors as you drive, so it is wise to consider an accessible mounting location. Scan the QR Code above to be directed to the troubleshooting guide or visit **t1x.us**.



Battery voltage is too low

The voltage to the controller has dropped below 8 volts.

Battery voltage is too high

The voltage to the controller is above 17.2 volts.

Shift Solenoid A (SSA) overcurrent error

An over-current condition was detected on the indicated shift solenoid. A short circuit may be present in the solenoid circuit. The controller will attempt to disable the solenoid with the over-current condition until the ignition is turned off.

Shift Solenoid B (SSB) overcurrent error

An over-current condition was detected on the indicated shift solenoid. A short circuit may be present in the solenoid circuit. The controller will attempt to disable the solenoid with the over-current condition until the ignition is turned off.

Coast Clutch Solenoid overcurrent error

An over-current condition was detected on the coast clutch solenoid. A short circuit may be present in the solenoid circuit. The controller will attempt to disable the coast clutch solenoid until the ignition is turned off.

TCC Solenoid overcurrent error

An over-current condition was detected on the torque converter clutch pressure solenoid. A short circuit may be present in the solenoid circuit. The controller will attempt to disable the TCC solenoid until the ignition is turned off.

EPC (PCS) Solenoid overcurrent error

An over-current condition was detected on the line pressure control solenoid. A short circuit may be present in the solenoid circuit. The controller will attempt to disable the solenoid with the over-current condition until the ignition is turned off.

Shift Solenoid A (SSA) undercurrent error

Current measured on the indicated shift solenoid was too low, indicating that the solenoid circuit may be open.

Shift Solenoid B (SSB) undercurrent error

Current measured on the indicated shift solenoid was too low, indicating that the solenoid circuit may be open.

Coast Clutch Solenoid undercurrent error

Current measured on the coast clutch solenoid was too low, indicating that the solenoid circuit may be open. The controller will attempt to disable the coast clutch solenoid until the ignition is turned off.

TCC Solenoid undercurrent error

Current measured on the torque converter clutch pressure solenoid was too low, indicating that the solenoid circuit may be open. The controller will attempt to disable the TCC solenoid until the ignition is turned off.

EPC (PCS) Solenoid undercurrent error

Current measured on the line pressure control solenoid was too low, indicating that the solenoid circuit may be open.

Shift Solenoid A (SSA) circuit shorted

The indicated Shift Solenoid's resistance measured too low during the power-on solenoid check. Refer to the data display screen in the diagnostic menu to see the measured solenoid resistance.

Shift Solenoid B (SSB) circuit shorted

The indicated Shift Solenoid's resistance measured too low during the power-on solenoid check. Refer to the data display screen in the diagnostic menu to see the measured solenoid resistance.

Coast Clutch Solenoid circuit shorted

The coast clutch solenoid resistance measured too low during the power-on solenoid check. The controller will attempt to disable the coast clutch solenoid until the ignition is turned off. Refer to the data display screen in the diagnostic menu to see the measured solenoid resistance.

TCC Solenoid circuit shorted

TCC pressure solenoid resistance measured too low during the power-on solenoid check. The controller will attempt to disable the TCC solenoid until the ignition is turned off. Refer to the data display screen in the diagnostic menu to see the measured solenoid resistance.

EPC (PCS) Solenoid circuit shorted

Line Pressure Control Solenoid resistance measured too low during the power-on solenoid check. Refer to the data display screen in the diagnostic menu to see the measured solenoid resistance.

Shift Solenoid A (SSA) circuit open

The indicated Shift Solenoid's resistance measured too high during the power-on solenoid check. Refer to the data display screen in the diagnostic menu to see the measured solenoid resistance.

Shift Solenoid B (SSB) circuit open

The indicated Shift Solenoid's resistance measured too high during the power-on solenoid check. Refer to the data display screen in the diagnostic menu to see the measured solenoid resistance.

Coast Clutch Solenoid circuit open

The coast clutch solenoid resistance measured too high during the power-on solenoid check. The controller will attempt to disable the coast clutch solenoid until the ignition is turned off. Refer to the data display screen in the diagnostic menu to see the measured solenoid resistance.

TCC Solenoid circuit open

TCC pressure solenoid resistance measured too high during the power-on solenoid check. The controller will attempt to disable the TCC solenoid until the ignition is turned off. Refer to the data display screen in the diagnostic menu to see the measured solenoid resistance.

EPC (PCS) Solenoid circuit open

Line Pressure Control Solenoid resistance measured too high during the power-on solenoid check. Refer to the data display screen in the diagnostic menu to see the measured solenoid resistance.

TPS Voltage Low; run TPS Setup

The Throttle Position Sensor is in fault mode due to the voltage being below the idle threshold value that was set. Run TPS calibration in the setup menu.

TFT Circuit Voltage Low or Shorted

The Transmission Fluid Temperature sensor voltage is too low. A possible cause of this could be that it is shorted to ground.

TFT Circuit Voltage High or Open

The Transmission Fluid Temperature sensor voltage is too high. The TFT sensor circuit could be open.

Transmission is Overheating

The temperature in the transmission is above the allowed threshold (which can be adjusted in the tuning software).

OSS Circuit Open or Sensor Missing

The Output Shaft Speed Sensor circuit is open or the sensor is missing.

ISS Circuit Open or Sensor Missing

The Input Shaft (Turbine) Speed Sensor circuit is open or the sensor is missing. (if equipped)

OSS Sensor Signal Plausibility Error

The controller detected an unexpected value from this sensor and marked it as faulty.

ISS Sensor Signal Plausibility Error

The controller detected an unexpected value from this sensor and marked it as faulty. (if equipped)

Checksum error in table (Can be table 1-4)

A Checksum error has been found in the table corresponding to the number shown. On Quick 6, this error will force a hard failsafe mode until it is fixed. It will also disable the tuning menu for the bad table. Connect the controller to a PC and load a calibration using Shiftware.

Torque Converter Clutch Slip Error

Torque converter clutch slip detected when fully engaged.

Transmission Slip in Gear(s) 1, 2, 3, etc.

Transmission appears to be slipping in the indicated gear or gears.

Transmission Slip with Max Pressure

Transmission continued to slip after maximum line pressure was commanded.

Transmission Slip Repeated > 2x

Transmission slip was detected more than twice in this drive cycle (max. line pressure latched).

Ratio too High in Gear(s) 2, 3, 4, etc.

Transmission gear ratio appears to be too high in the indicated gear or gears.

Error: PRNDL Out of Range

Sensor voltage is out of tolerance limits, but within approximate range.

Error: PRNDL Signal Low

Sensor voltage is low.

Error: PRNDL Signal High

Sensor voltage is high.

Error: No PRNDL PWM Signal

Connect the controller to a PC and use Shiftware to reload the calibration using a E4OD calibration.

Error: Invalid PRNDL Code=XX-XX

DTR or PSM signal combination not valid. XX-XX indicates high/low status of all 4 DTR pins (1 or 0)

Error: Ford DTR Voltage too Low

Voltage from 270 Ohm resistor in Ford DTR sensor measures too low.

Error: Ford DTR Voltage too High

Voltage from 270 Ohm resistor in Ford DTR sensor measures too high.

Low-Side Driver Shorted

A low-side output driver appeared to be shorted on during power-on solenoid check. Contact Baumann Electronic Controls technical support for assistance.

CONTACT

If you have any questions, problems, or product orders,
don't hesitate to call our customer service line.

(864) 646-8920

(Monday-Friday 10AM-6PM EST).

If no one is available, please leave a detailed message and we will reply promptly. Whenever possible, we will try to return urgent technical support calls left after hours or over the weekend.

You can also email customer service at **support@usshift.com**



Scan this code to copy the customer service phone number and email address to your phone.